

# Hydra-Cell®

Seal-less Pump Technology



 **WANNER INTERNATIONAL**

 **PromoTec**

## Hydra-Cell G Series Seal-less Pumps



## Hydra-Cell T Series Seal-less Pumps



## Hydra-Cell Q Series Seal-less Pumps



## Hydra-Cell Seal-less Metering Solutions Pumps





# Hydra-Cell® Seal-less Pumps

Contents	Page
Markets & Industries Served.....	3
Primary Applications.....	5
Liquid Handling Capability .....	6
Principles of Operation	
Wobble Plate Design.....	7
Crank-shaft Design.....	8
T & Q Series .....	9
Hydra-Cell Compliance Certifications.....	10
Materials of Construction.....	11
G Series	
Selection Guide.....	13
Flow Capacities & Pressure Ratings.....	14
Performance Graphs & Specifications .....	15
C Series Valves .....	20
T & Q Series	
Selection Guide.....	21
Flow Capacities & Pressure Ratings.....	22
T Series Performance graphs and specifications .....	23
Q Series Performance graphs and specifications.....	25
Dosing Pumps	
Selection Guide .....	27
Flow Capacities & Pressure Ratings.....	28
MT8 and P Series	
Selection Guide .....	29
Flow Capacities & Pressure Ratings.....	30
Performance graphs and specifications .....	31
S Series.....	38
Control Options.....	39
Accessories & Options .....	40
Worldwide Sales & Service.....	41
Application Worksheet .....	43
Notes.....	44



“If the owner of a plant wants cost-effective pumps... he will buy pumps with the lowest Life Cycle Cost. Hydra-Cell is simple in construction, less elaborate in design and physically smaller for equivalent flow/pressure performance. These differences can substantially affect both purchase and operating costs.”

*Ing Friedrich-Wilhelm Hennecke, Ph.D. Chemical Engineering World*

*Dr. Hennecke served on the Faculty of Chemical Engineering, Karlsruhe, and as a plant engineer, specifying pumps at BASF AG for 30 years.*



## Wanner Engineering ISO 9001: 2008 Certification

Wanner Engineering has earned ISO 9001: 2008 certification, the culmination of our on-going work and commitment to providing our customers with industry leading value in pumps and equipment. The certification was authorized by TÜVRheinland, a premier global provider of independent testing and certification services.

Certification of our Quality Management System shows how we have embraced a continuous improvement process that results in world-class products delivered on time, and at the best price and will ensure that Wanner Engineering will continue to provide the outstanding quality that our customers have come to expect, and rely on, from our pumps and equipment.

*Due to the Wanner Engineering Continuous Improvement Program, specifications and other data in this catalogue are subject to change.*

## Wanner International ISO 9001: 2015 Certification

The administration systems of Wanner International Ltd., in connection with pumps and associated products, have also been assessed and approved by the independent body QAS International to the standards laid down under ISO 9001:2015 (the latest version of ISO 9001).

It covers all aspects of administration including the systems in place for purchase and supply, handling enquiries and orders, internal and external communication, maintenance of records and the creation and handling of documents. It also covers the arrangements made for the continual review and improvement of its QM systems. The approved administration systems apply to the design, manufacture, assembly and distribution of pumps and associated products.

*Hydra-Cell® is a registered trademark of Wanner Engineering, Inc. Kel-Cell® is a registered trademark of Wanner Engineering, Inc.*

## Hydra-Cell® Application Versatility

*Hydra-Cell pumps operate reliably and efficiently in commercial, institutional, industrial, and municipal facilities throughout the world. The breadth of the product line offers a wide range of flow capacities and pressure ratings to meet many different requirements.*

*The further capability to provide precise metering and dosing is ideal for many specialised applications. Hydra-Cell pumps can also be fitted with ANSI, DIN, SAE or other specialised flange connections.*

## Markets and Industries Served

- Automotive
- Biodiesel
- Biotechnical
- Car/Vehicle Washing
- Ceramics
- Chemical & Petrochemical
- Chip Board Manufacturing
- Cleaning & Washing
- Construction
- Electronics
- Emissions & Environmental Control





- Energy & Power Generation
- Energy Recovery - ORC
- Flue Gas Emission Control
- Food & Beverage Processing
- General Industrial & Manufacturing
- Glass & Clay
- Lawn Care & Agriculture
- Marine
- Machine Tool Coolant
- Mining, Quarrying & Tunnelling
- Offshore Drilling & Processing
- Oil, Gas & Petrochemical
- Paints, Coatings, Sealants & Adhesives
- Personal Care
- Pharmaceutical
- Polyurethane
- Propellant Packaging
- Pulp & Paper
- Reverse Osmosis & Filtration
- Rubber & Plastic
- Spray Drying
- Steam Generation
- Steel
- Textiles
- Tote, Tank & Barrel Washing
- Water, Effluent & Wastewater Treatment





# Hydra-Cell® Primary Pumping Applications

- Blending
- Cleaning
- Coating
- Dosing
- Filling
- Filtering
- Injecting
- Metering
- Mixing
- Sampling
- Spraying
- Transferring



*Hydra-Cell pumps deliver high-pressure, controlled flow of machine tool coolant without the need for fine filtration.*



*High-precision dosing of pentane at low flow rates can be achieved for specialised applications in polyurethane processing.*



*Hydra-Cell pumping shear-sensitive polymers for enhanced oil recovery.*



*Pumping for waste stream reduction and salt solution concentration at a pharmaceutical chemical plant*

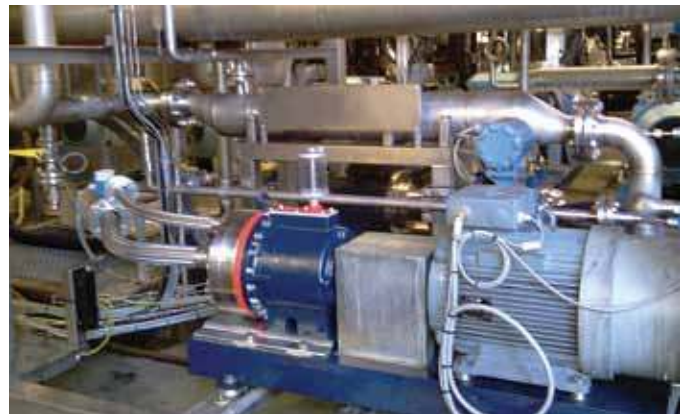

*Hydra-Cell pumps used for ultra-filtration by a food additive manufacturer.*



# Hydra-Cell® Liquid Handling Capability



Propane/ Butane   Freon   Ammonia   Polymers   Fuels/ Additives   D.I. Water   Glycols   Chlorine   Acids/ Caustics   Glues/ Adhesives   Inks/ Paints   Resins   Slurries

## Handles Low-to-High-Viscosity Liquids

From drinking water to highly viscous cutting liquids, Hydra-Cell pumps handle the full spectrum of process liquids while maintaining high-efficiency operation. This includes

non-lubricating liquids as well as difficult liquids with abrasives that can damage or destroy other types of pumps. This makes Hydra-Cell an ideal choice in a wide range of industries and when serving multiple applications in one facility.



Hydra-Cell T100 pumping gasoline in a distribution centre.



Several operational features of Hydra-Cell pumps are showcased when processing volatile crude oil.



Wastewater treatment is a difficult pumping application that Hydra-Cell routinely handles.



Pumping dirty and recycled water at a commercial car wash is an everyday function for Hydra-Cell pumps.



Hydra-Cell pumping ethanol-based liquid for making jet fuel.

# Hydra-Cell® Principles of Operation - Wobble Plate

API 674 option available

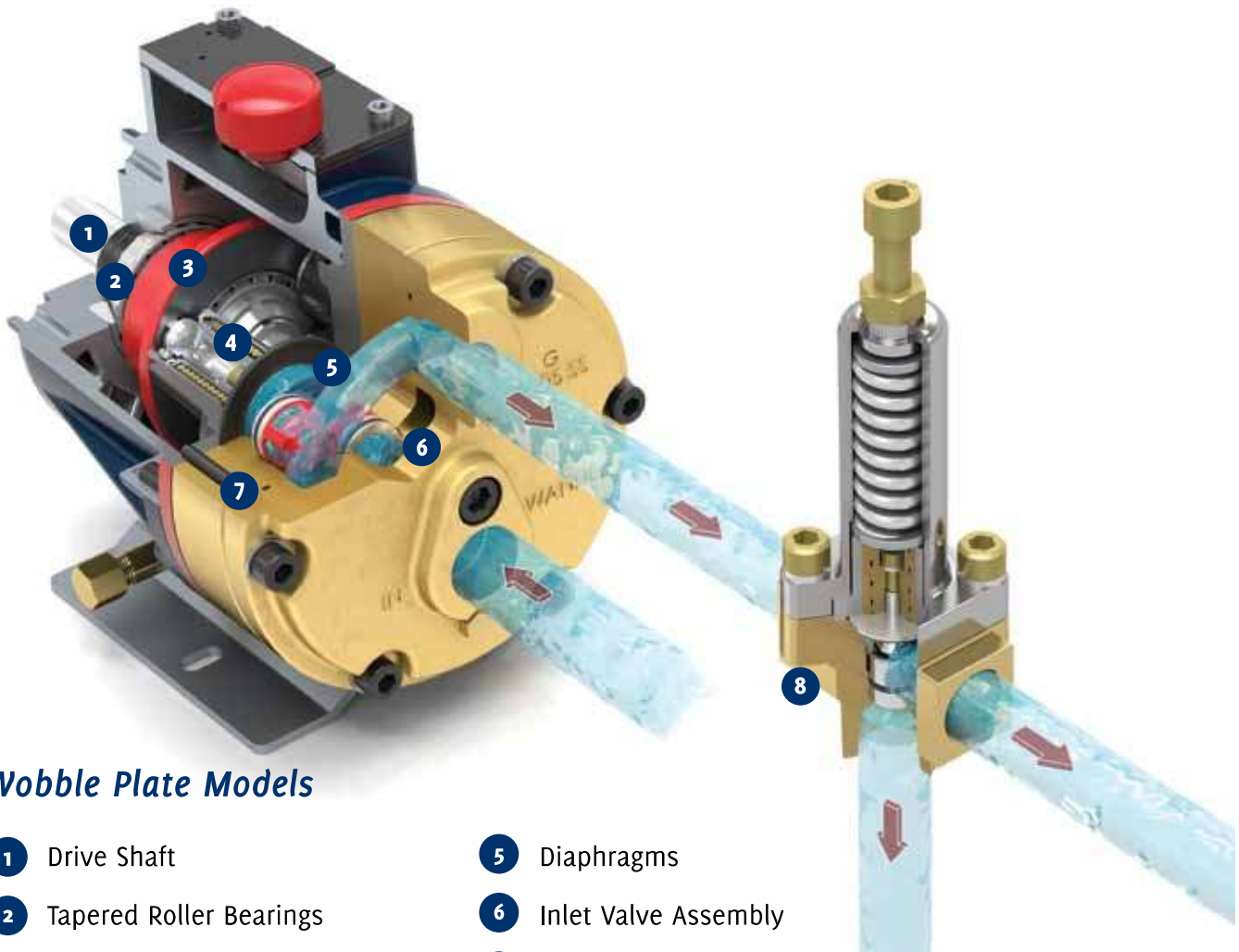

## Wobble Plate Models

- |                                |                                 |
|--------------------------------|---------------------------------|
| 1 Drive Shaft                  | 5 Diaphragms                    |
| 2 Tapered Roller Bearings      | 6 Inlet Valve Assembly          |
| 3 Fixed-angle Cam/Wobble Plate | 7 Discharge Valve Assembly      |
| 4 Hydraulic Cells (Patented)   | 8 C62 Pressure Regulating Valve |

## Reliable, Efficient Pumping Action

The drive shaft (1) is rigidly held in the pump housing by a large tapered roller bearing (2) at the rear of the shaft and a smaller bearing at the front of the shaft. Set between another pair of large bearings is a fixed-angle cam or Wobble Plate (3).

As the drive shaft turns, the swash plate moves, oscillating forward and back (converting axial motion into linear motion). The complete pumping mechanism is submerged in a lubricating oil bath.

The hydraulic cell (4) is moved sequentially by the Wobble plate and filled with oil on their rearward stroke. A ball check valve in the bottom of the piston ensures that the cell remains full of oil on its forward stroke.

The oil held in the Hydra-Cell balances the back side of the diaphragms (5) and causes the diaphragms to flex forward and back as the Wobble plate moves. This provides the pumping action.

To provide long trouble-free diaphragm life, Hydra-Cell hydraulically balances the diaphragm over the complete

pressure range of the pump. The diaphragm faces only a 0.21 bar pressure differential regardless of the pressure at which liquid is being delivered - up to 172 bar on standard Hydra-Cell models and Hydra-Cell metering pumps.

Hydra-Cell Wobble plate pumps can have up to five diaphragms, and each diaphragm has its own pumping chamber that contains an inlet and discharge self-aligning spring loaded check valve assembly (6). As the diaphragms move back, liquid enters the pump through a common inlet and passes through one of the inlet check valves. On the forward stroke, the diaphragm forces the liquid out the discharge check valve (7) and through the manifold common outlet. Equally spaced from one another, the diaphragms operate sequentially to provide consistent, low-pulse flow.

A Hydra-Cell C62 pressure regulating valve (8) is typically installed on the discharge side of the pump to regulate the pressure of downstream process or equipment.



# Hydra-Cell® Principles of Operation - Crankshaft

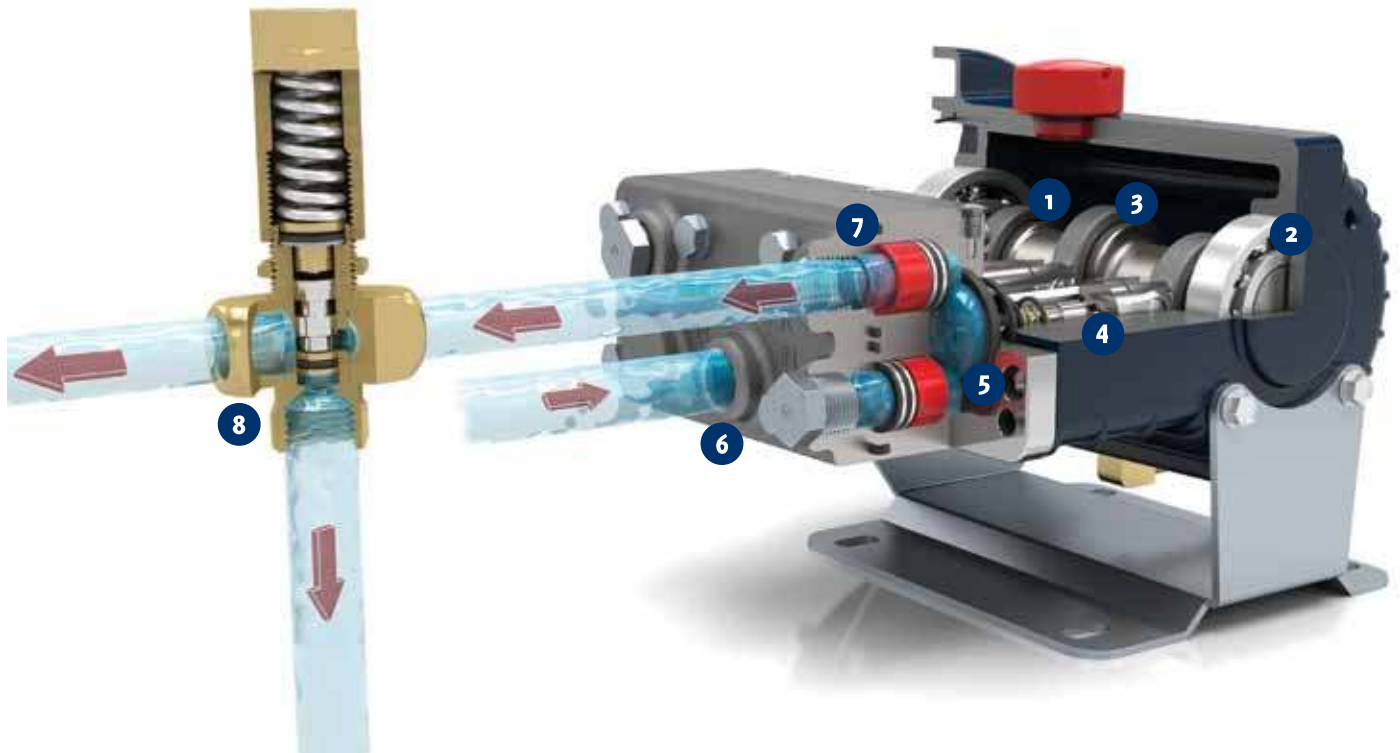

## Crank-shaft Models

- |                              |   |
|------------------------------|---|
| 1 Drive Shaft                | 5 Diaphragms                              |
| 2 Precision Ball Bearings    | 6 Inlet Valve Assembly                    |
| 3 Connecting Rods            | 7 Discharge Valve Assembly                |
| 4 Hydraulic Cells (Patented) | 8 C46 Pressure Regulating Valve (In-line) |

## Reliable, Efficient Pumping Action

The drive shaft (1) is supported in position by two precision ball bearings (2) positioned at either end of the shaft. Located between these bearings are either one or three cam shaft lobes with connecting rods (3) that are hardened, precision ground, and polished. Maintaining a high level of quality on the cam lobes and connecting rod surfaces ensures proper lubrication and reduced operating temperatures in the hydraulic end of the pump.

As the drive shaft turns, each cam actuates the attached connecting rod that is pinned into position at the end of each hydraulic piston. This action moves the piston forward and backward, converting the axial motion into linear pumping motion. The complete pumping mechanism is submerged in a lubricating oil bath.

Each piston contains a patented hydraulic cell (4) that is moved sequentially by the crank-shaft. The innovative and proprietary Hydra-Cell maintains the precise balance of oil behind the diaphragm (5) regardless of the operating conditions of the pump. The oil in Hydra-Cell is pressurized on the forward stroke of the piston causing the diaphragm to flex,

which drives the pumping action. The oil held in the Hydra-Cell balances the diaphragm against the liquid being pumped, maintaining no more than a 0.21 bar differential regardless of the pressure at which the liquid is being delivered - up to 172 bar on standard Hydra-Cell models and Hydra-Cell metering pumps.

Hydra-Cell crank-shaft pumps can have up to three diaphragms, and each diaphragm has its own pumping chamber that contains an inlet and discharge self-aligning spring loaded check valve assembly (6). As the diaphragms move back, liquid enters the pump through a common inlet and passes through one of the inlet check valves. On the forward stroke, the diaphragm forces the liquid out of the discharge check valve (7) and through the manifold common outlet. Equally spaced from one another, the diaphragms operate sequentially to provide consistent, low-pulse flow.

A Hydra-Cell C46 pressure regulating valve (8) is typically installed on the discharge side of the pump to regulate the pressure of downstream process or equipment.

# Hydra-Cell® Principles of Operation - Asynchronous Design

API 674 option available

Exclusive Seal-less Diaphragm Design

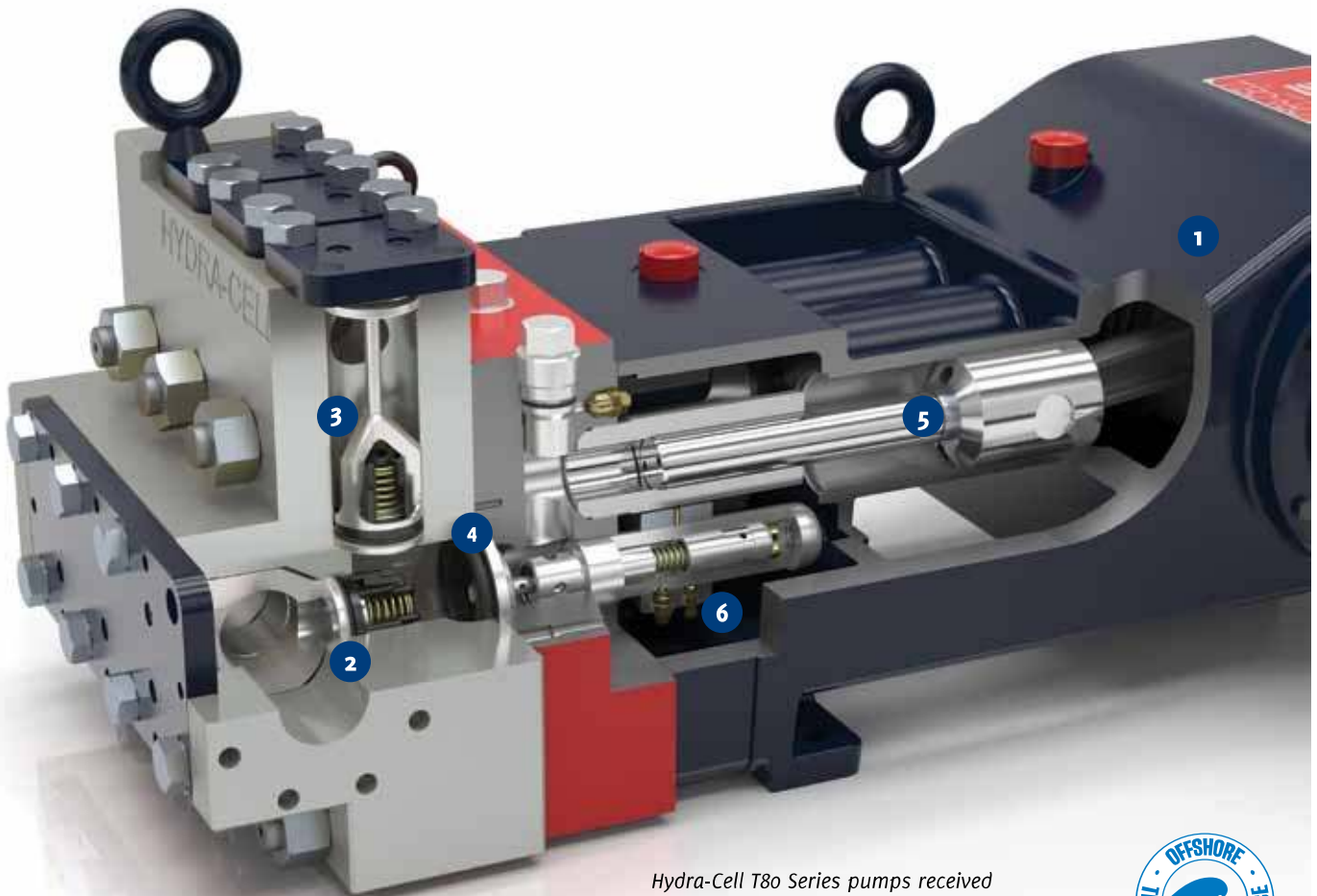

Hydra-Cell T80 Series pumps received a "Spotlight on New Technology" award from the Offshore Technology Conference.



## Asynchronous Models

- |                            |                                 |
|----------------------------|---------------------------------|
| 1 Drive Shaft              | 4 Diaphragms                    |
| 2 Inlet valve assembly     | 5 Plunger                       |
| 3 Discharge valve assembly | 6 Underfill and overflow valves |

## Reliable, Efficient Pumping Action

The seal-less design of Hydra-Cell High Horsepower pumps eliminates leaks, hazards and the expense associated with seals and packing. The diaphragms completely separate the process liquid from the pump drive with no dynamic seals or packing being exposed to the pumped liquid.

The pump's high efficiency results in lower energy costs than centrifugal pumps and other pump technologies, while the simple, asynchronous design and exceptionally rugged construction lead to very low maintenance and service requirements. The hydraulically balanced diaphragms are able to handle high pressures with low stress.

These pumps can operate with a closed or blocked suction line and can run dry indefinitely without damage, eliminating downtime and repair costs. Their low NPSH requirements allow for operation with a vacuum condition on the suction... positive suction pressure is not necessary.

Thanks to unique diaphragm and valve designs, these pumps are able to handle more abrasives with less wear than gear, screw or plunger pumps. Their compact design and double-ended shaft provide a variety of installation options.

Hydra-Cell High Horsepower pumps can be configured to meet API 674 standards – consult factory for details



# Hydra-Cell® Compliance Certifications

## ATEX

ATEX is the directive applied to the use and sustainability of equipment allowed for installation in above-ground, explosive atmospheres. The full line of Hydra-Cell ATEX

pumps are classified in Group II, Category 2 (Zone 1) for both gasses and dust. Temperature classification is T4 135 °C permitting a maximum process temperature of 90 °C.



## CE Marking

CE identifies compliance of Hydra-Cell pumps with Essential Health and Safety Requirements

(EHSR) of the European Union. This includes the Safety of Machinery Directive 98/37/EC.



## DNV

Det Norske Veritas (DNV) is a maritime classification society, that for pumps, details intended service, flow/pressure ratings and service restrictions while specifying the destination vehicle. Hydra-Cell DNV individually test & certified pumps overcome the problems associated with pumping and metering low-

viscosity, low-sulfur fuels as dictated for use in Sulfur Emissions Control Areas (SECA). They are also used for pumping residual fuel oils, seawater, FGD treatment chemicals, and for ballast treatment.



## ISO 9001: 2015

ISO 9001 is an independent continuing assessment of an organisation's arrangements for Quality Management. It covers all aspects of administration including the systems in place for purchase and supply, handling enquiries and orders, internal and external communication, maintenance of records and the creation and handling of documents. It also covers the arrangements made for the

continual review and improvement of its QM systems.

The administration systems of Wanner International Ltd in connection with pumps and associated products have been assessed and approved by the independent body QAS International to the standards laid down under ISO 9001:2015 (the latest version of ISO 9001).



## ISO 14001: 2004

ISO 14001 is an internationally accepted standard that brands a business as environmentally responsible, committed to reducing environmental impacts and meeting expectations of sustainability as the business grows.

the independent body QAS International to the standards laid down under ISO 14001:2004. This ensures that the necessary ISO 14001 procedures and controls have been developed by the company and that they are being implemented and working satisfactorily as required.



To obtain Certification, Wanner International Ltd has undergone a two-part formal assessment by

## LLOYDS REGISTER

Wanner International is able to supply Hydra-Cell pumps for marine duties in compliance with the requirements of Lloyd's Register. Certificates for these pumps, backed by

independent Witness Tests, have been issued by LR for duties that include transfer of low-sulphur fuels.

LR certified Hydra-Cell diaphragm pumps overcome difficulties associated with pumping light viscosity oils and other poor lubricants.

## TR CU

Supervised by Rosstandart (Federal Agency for Technical Regulation & Metrology), the new TR CU certificate now replaces GOST-R.

Covering the three states of the Customs Union - Russia, Belarus & Kazakhstan, the main objectives of the certificate is to:

- To protect safety, health and environment of consumers & users of goods
- To prove compliance of products to Russian and Customs Union safety requirements

- Required for Customs clearance procedures at the Russian & CU border
  - Required for the sale and use of products in the local market
- The new TR CU certificate allows for the safe use of equipment in explosive atmospheres and is mandatory for any electrical equipment that is installed or operated in hazardous or potentially explosive atmospheres in the countries.



## Hydra-Cell® Materials of Construction

As part of our “Mass Customisation” philosophy, every Hydra-Cell pump is built with manifolds, elastomeric materials, and valve assemblies using construction materials specified by the customer. Hydra-Cell distributors and factory representatives are readily available to assist customers in selecting the materials best suited to the process application. (The range of material choices depends on each pump model – for example, models designed to operate at higher pressures are available with metallic pump heads only.)

### Manifolds

Manifolds for Hydra-Cell pumps are available in a variety of materials to suit your process application. They are easy to replace and interchangeable to accommodate different liquids processed by the same pump. Special manifolds with a 2:1 dosing ratio are also available. (Consult factory.)

### Non-metallic Pump Heads

Non-metallic pump heads are often used when a corrosive or aggressive liquid is being processed at lower pressures.

- Polypropylene
- PVDF

### Metallic Pump Heads

Metallic pump heads can handle higher operating pressures. Hastelloy CW12MW or Stainless Steel is also selected for corrosion resistance and other properties.

- Brass
- Bronze
- Cast Iron (Nickel-plated)
- Ductile Iron (Nickel Plated)
- Duplex Alloy 2205
- Super Duplex Alloy 2507
- Hastelloy CW12MW
- 304 Stainless Steel
- 316L Stainless Steel



### Diaphragms and O-rings

Diaphragms and corresponding o-rings are available in several elastomeric materials.

- Aflas (used with PTFE and FFKM O-rings)
- Butyl
- Buna-N
- EPDM (requires EPDM-compatible oil)
- FFKM
- FKM
- Neoprene
- PTFE







### Valve Springs

- Elgiloy (Exceeds SST grade 316L)
- Hastelloy CW12MW
- 17-7 PH Stainless Steel
- 316L Stainless Steel

### Valve Spring Retainers

- Celcon
- Hastelloy CW12MW
- Nylon (Zytel)
- Polypropylene
- PVDF
- 17-7 PH Stainless Steel

### Valve Materials

Hydra-Cell valve assemblies (seats, valves, springs, and retainers) are available in a variety of materials to suit your process application.

#### Valve Seats

- Ceramic
- Hastelloy CW12MW
- Nitronic 50
- Tungsten Carbide
- 17-4 PH Stainless Steel
- 316L Stainless Steel

#### Valves

- Ceramic
- Hastelloy CW12MW
- Nitronic 50
- Tungsten Carbide
- 17-4 PH Stainless Steel

### Registered trademarks of materials:

Aflas®	Asahi Glass Co., Ltd.
Buna®-N (Nitrile)	E.I. Du Pont de Nemours and Company, Inc.
Celcon®	Celanese Company
Elgiloy®	Elgiloy Limited Partnership
Hastelloy® CW12MW	Haynes International, Inc.
Kynar® (PVDF)	Arkema, Inc.
Mesamoll®	Lanxess Deutschland GmbH
Neoprene®	E.I. Du Pont de Nemours and Company, Inc.
Nitronic® 50	AK Steel Corporation
Teflon® (PTFE)	E.I. Du Pont de Nemours and Company, Inc.
Viton® (FKM)	DuPont Performance Elastomers, LLC
Zytel® (Nylon)	E.I. Du Pont de Nemours and Company, Inc.

# Hydra-Cell® G Series Seal-less Pumps



G20



G03



G03 Mono-Block



G04



G10



G12



G15



G17



G25



G35



G66



# Hydra-Cell® Flow Capacities and Pressure Ratings

## G Series Seal-less Pumps

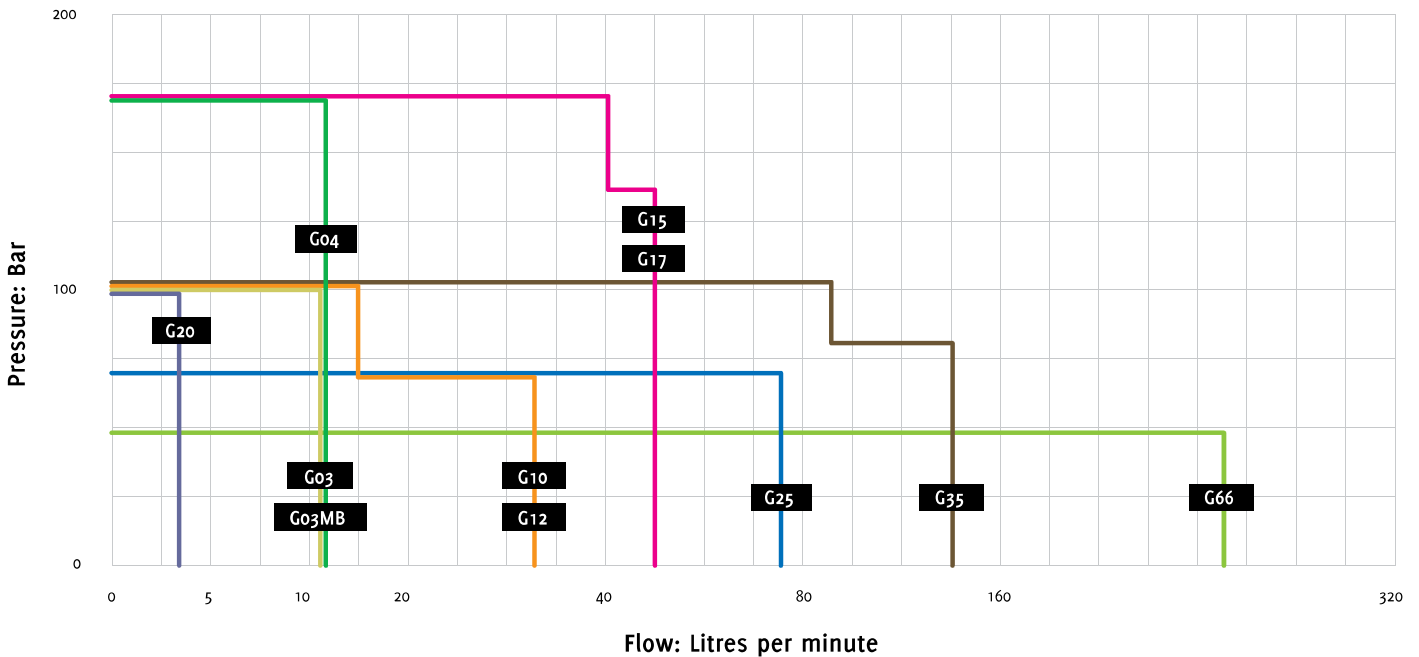

The graph above displays the maximum flow capacity at a given pressure for each model series. The table below lists the maximum flow capacity and maximum pressure capability of each model series.

Please Note: Some models do not achieve maximum flow at maximum pressure. Refer to the individual model specifications in this section for precise flow and pressure capabilities by specific pump configuration.

Model	Maximum Capacity l/min	Maximum Discharge Pressure bar		Maximum Operating Temperature °C <sup>2</sup>		Maximum Inlet Pressure bar
		Non-Metallic <sup>1</sup>	Metallic	Non-Metallic	Metallic	
G20	3.8	24	103	60°	121°	17
G03	11.7	24	103	60°	121°	17
G04	11.2	N/A	172	N/A	121°	34
G10	33.4	24	103	60°	121°	17
G12	33.4	N/A	103	N/A	121°	17
G15	58.7	N/A	172	N/A	121°	34
G17	58.7	N/A	172	N/A	121°	34
G25	75.9	24	69	60°	121°	17
G35	138	N/A	103	N/A	121°	34
G66	248	17	48	49	121°	17

<sup>1</sup> 24 bar maximum with PVDF (Kynar®) liquid end; 17 bar maximum with Polypropylene liquid end.

<sup>2</sup> Consult factory for correct component selection for temperatures from 160°F (71°C) to 250°F (121°C).

# Hydra-Cell® G Series Performance Graphs and Specifications

## G20

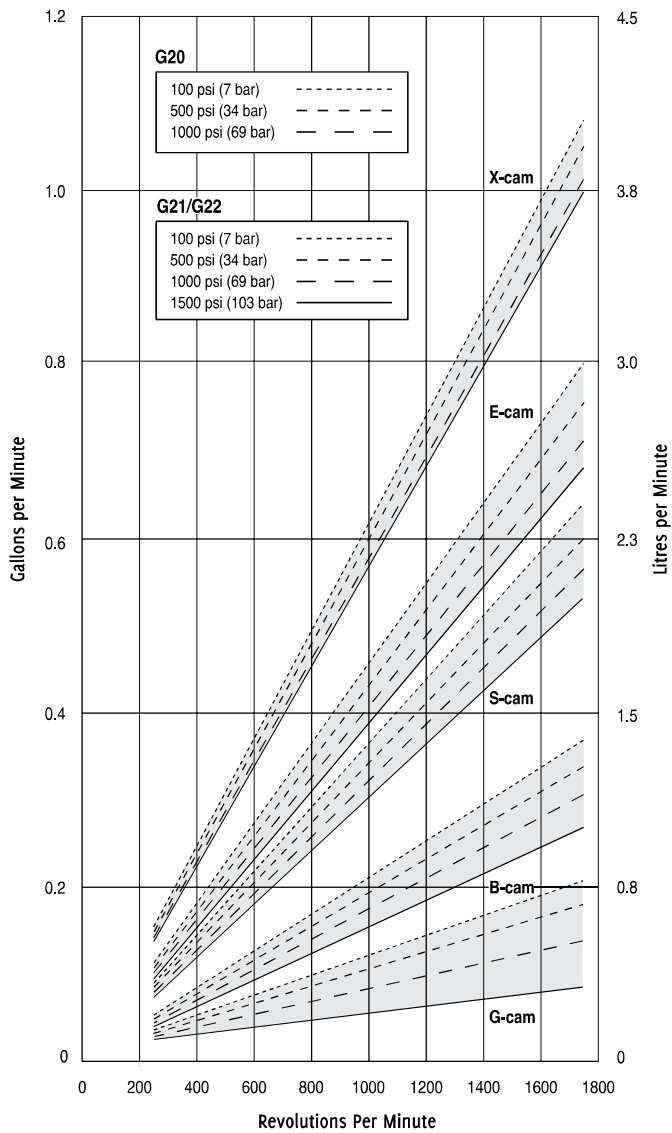

## G03

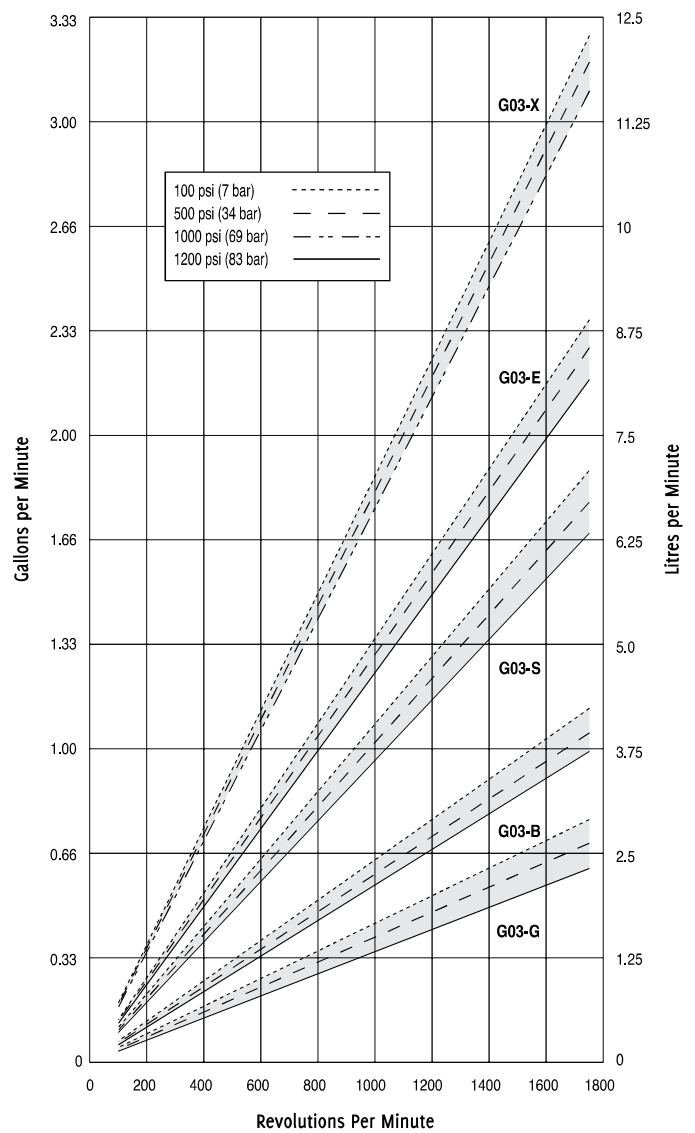

<b>Maximum Particle Size</b>	0.3mm @ 15% max. concentration
<b>Inlet Port</b>	1/2 inch BSPT (NPT option available)
<b>Discharge Port</b>	3/8 inch BSPT (NPT option available)
<b>Shaft Diameter</b>	
G-20:	3/4 inch (19mm) hollow shaft
G-21/22:	3/4 inch (19mm)
<b>Shaft Rotation</b>	Bi-directional
<b>Weight</b>	
Metallic Heads:	5.5 kg
Non-Metallic Heads:	4.1 kg

<b>Maximum Particle Size</b>	0.3mm @ 15% max. concentration
<b>Inlet Port</b>	1/2 inch BSPT (NPT option available)
<b>Discharge Port</b>	3/8 inch BSPT (NPT option available)
<b>Shaft Diameter</b>	
G-03:	7/8 inch (22.22 mm)
G-13:	24 mm hollow shaft
<b>Shaft Rotation</b>	Bi-directional
<b>Weight</b>	
Metallic Heads:	12.7 kg
Non-Metallic Heads:	8.6 kg

### Calculating Required Horsepower (kW)\*

$$\frac{\text{rpm} + 1000}{7000} + \frac{\text{gpm} \times \text{psi}}{1,460} = \text{electric motor HP}^*$$

$$\frac{\text{rpm} + 1000}{9383} + \frac{\text{l/min} \times \text{bar}}{511} = \text{electric motor kW}^*$$

### Calculating Required Horsepower (kW)\*

$$\frac{6 \times \text{rpm}}{63,000} + \frac{\text{gpm} \times \text{psi}}{1,460} = \text{electric motor HP}^*$$

$$\frac{6 \times \text{rpm}}{84,428} + \frac{\text{l/min} \times \text{bar}}{511} = \text{electric motor kW}^*$$

\* rpm equals pump shaft rpm. HP/kW is required application power. Use caution when sizing motors with variable speed drives.

Note: For the low flow cams (B, G, I), a 1 bar pressurised inlet feed must be used. Performance specifications are guidelines only.



# Hydra-Cell® G Series Performance Graphs and Specifications

## G04

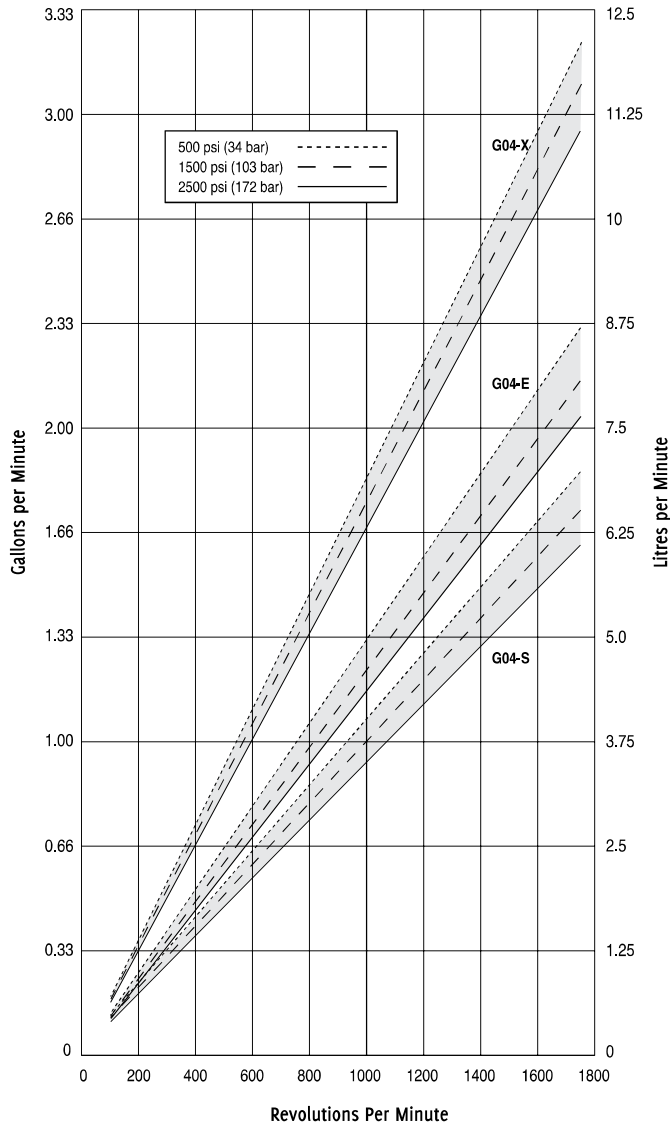

## G10 - API 674 option available

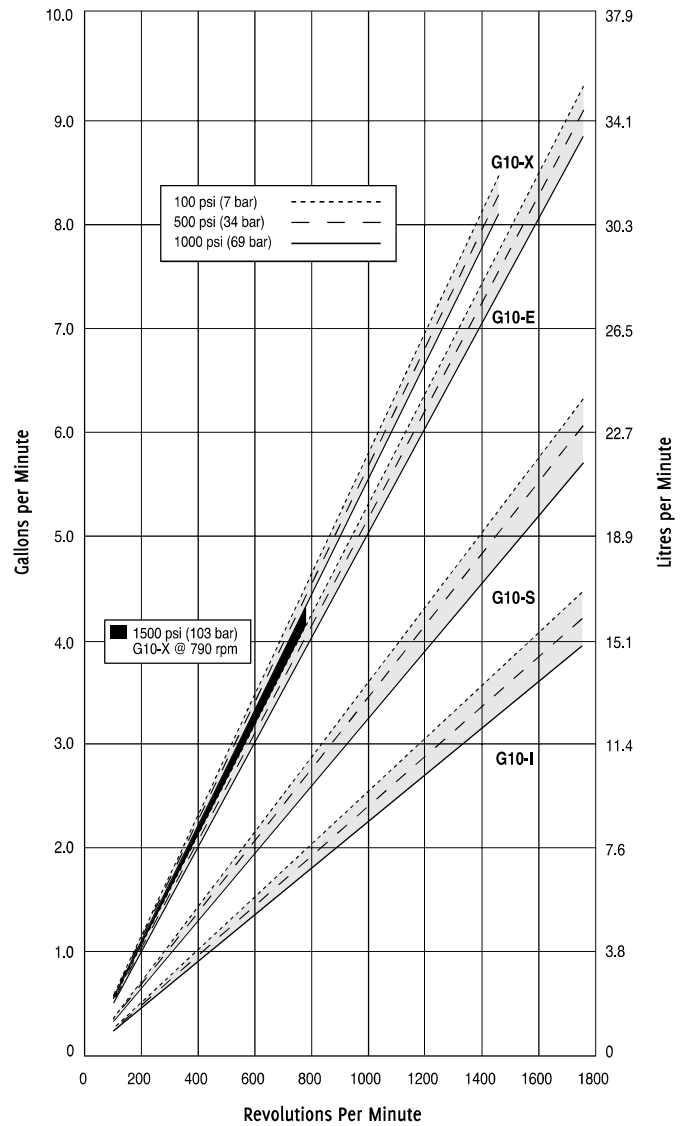

<b>Maximum Particle Size</b>	0.3mm @ 15% max. concentration
<b>Inlet Port</b>	1/2 inch BSPT (NPT option available)
<b>Discharge Port</b>	1/2 inch BSPT (NPT option available)
<b>Shaft Diameter</b>	7/8 inch (22.22 mm)
<b>Shaft Rotation</b>	Bi-directional
<b>Weight</b>	16.8 kg

<b>Maximum Particle Size</b>	0.8mm @ 5-10% max. concentration
<b>Inlet Port</b>	1 inch BSPT (NPT option available)
<b>Discharge Port</b>	3/4 inch BSPT (NPT option available)
<b>Shaft Diameter</b>	7/8 inch (22.22 mm)
<b>Shaft Rotation</b>	Bi-directional
<b>Weight</b>	
Metallic Heads:	22 kg
Non-Metallic Heads:	16 kg

### Calculating Required Horsepower (kW)\*

$$\frac{6 \times \text{rpm}}{63,000} + \frac{\text{gpm} \times \text{psi}}{1,460} = \text{electric motor HP}^*$$

$$\frac{6 \times \text{rpm}}{84,428} + \frac{\text{l/min} \times \text{bar}}{511} = \text{electric motor kW}^*$$

### Calculating Required Horsepower (kW)\*

$$\frac{15 \times \text{rpm}}{63,000} + \frac{\text{gpm} \times \text{psi}}{1,460} = \text{electric motor HP}^*$$

$$\frac{15 \times \text{rpm}}{84,428} + \frac{\text{l/min} \times \text{bar}}{511} = \text{electric motor kW}^*$$

\* rpm equals pump shaft rpm. HP/kW is required application power. Use caution when sizing motors with variable speed drives.

Note: For the low flow cams (B, G, I), a 1 bar pressurised inlet feed must be used. Performance specifications are guidelines only.

# Hydra-Cell® G Series Performance Graphs and Specifications

## G12

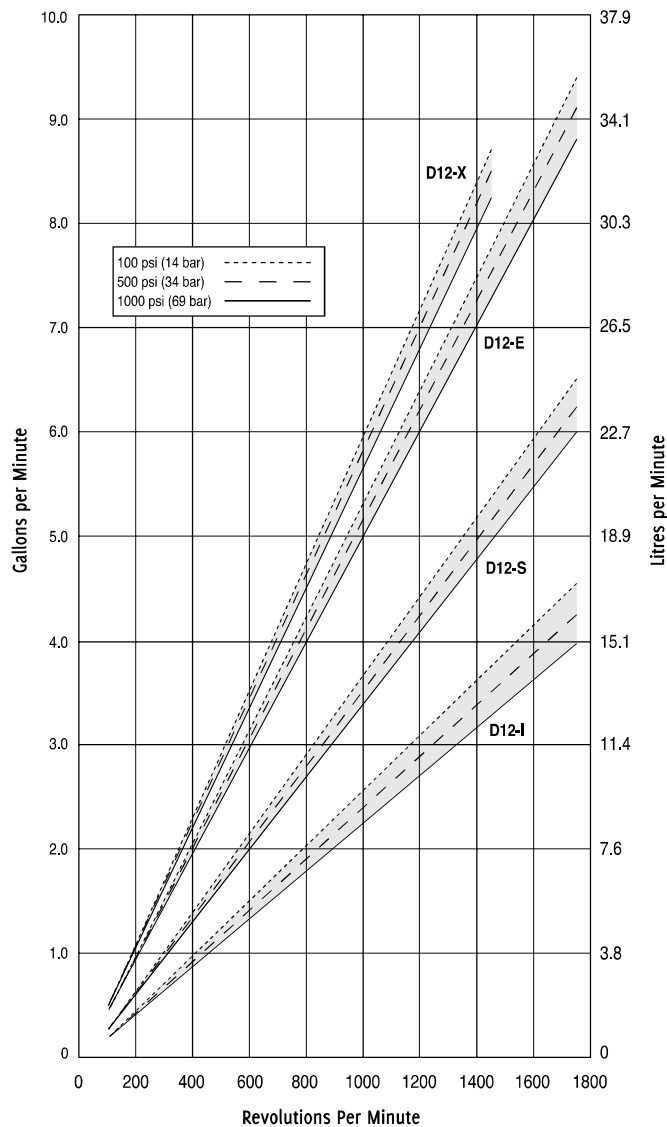

## G15 (horizontal) G17 (vertical) - API 674 option available

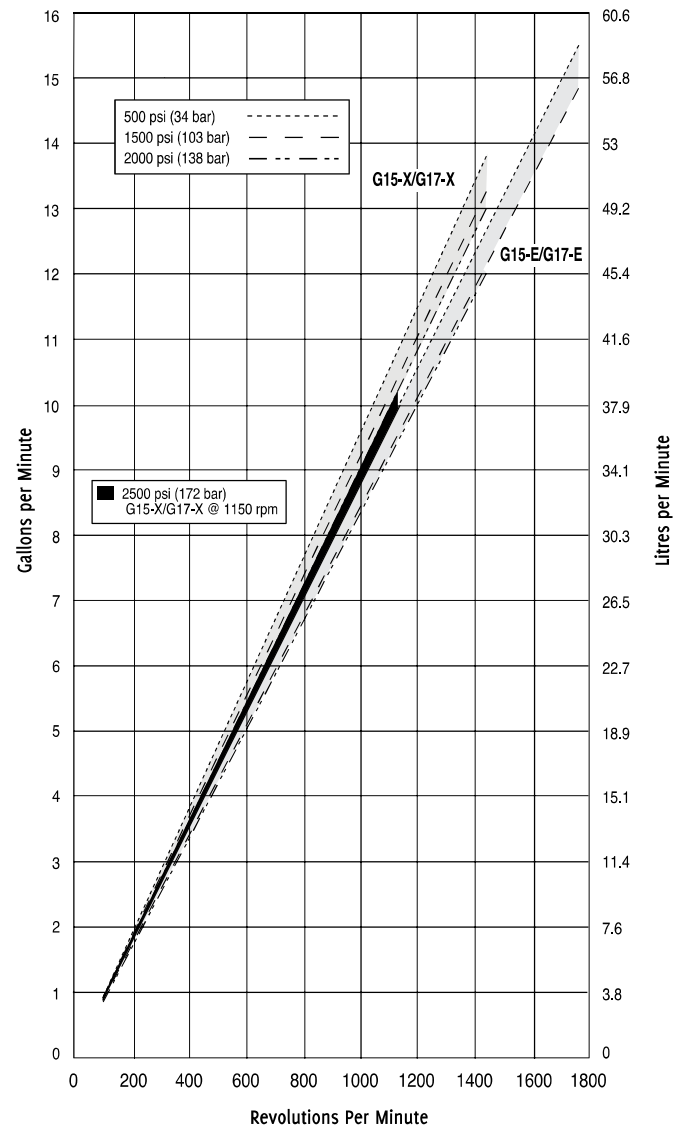

Maximum Particle Size	0.8mm @ 5-10% max. concentration
Inlet Port	1 inch BSPT (NPT option available)
Discharge Port	3/4 inch BSPT (NPT option available)
Shaft Diameter	7/8 inch (22.22 mm)
Shaft Rotation	Bi-directional
Weight	
Metallic Heads:	22 kg

Maximum Particle Size	0.3mm @ 15% max. concentration
Inlet Port	1-1/4 inch BSPT (NPT option available)
Discharge Port	3/4 inch BSPT (NPT option available)
Shaft Diameter	1-1/8 inch (28.58 mm)
Shaft Rotation	Bi-directional
Weight	66 kg

### Calculating Required Horsepower (kW)\*

$$\frac{15 \times \text{rpm}}{63,000} + \frac{\text{gpm} \times \text{psi}}{1,460} = \text{electric motor HP}^*$$

$$\frac{15 \times \text{rpm}}{84,428} + \frac{\text{l/min} \times \text{bar}}{511} = \text{electric motor kW}^*$$

### Calculating Required Horsepower (kW)\*

$$\frac{80 \times \text{rpm}}{63,000} + \frac{\text{gpm} \times \text{psi}}{1,460 - \left(\frac{\text{psi} - 500}{20}\right)} = \text{electric motor HP}^*$$

$$\frac{80 \times \text{rpm}}{84,428} + \frac{\text{l/min} \times \text{bar}}{511 - \left(\frac{\text{bar} - 35}{4}\right)} = \text{electric motor kW}^*$$

\* rpm equals pump shaft rpm. HP/kW is required application power. Use caution when sizing motors with variable speed drives.

Note: For the low flow cams (B, G, I), a 1 bar pressurised inlet feed must be used. Performance specifications are guidelines only.



# Hydra-Cell® G Series Performance Graphs and Specifications

## G25 - API 674 option available

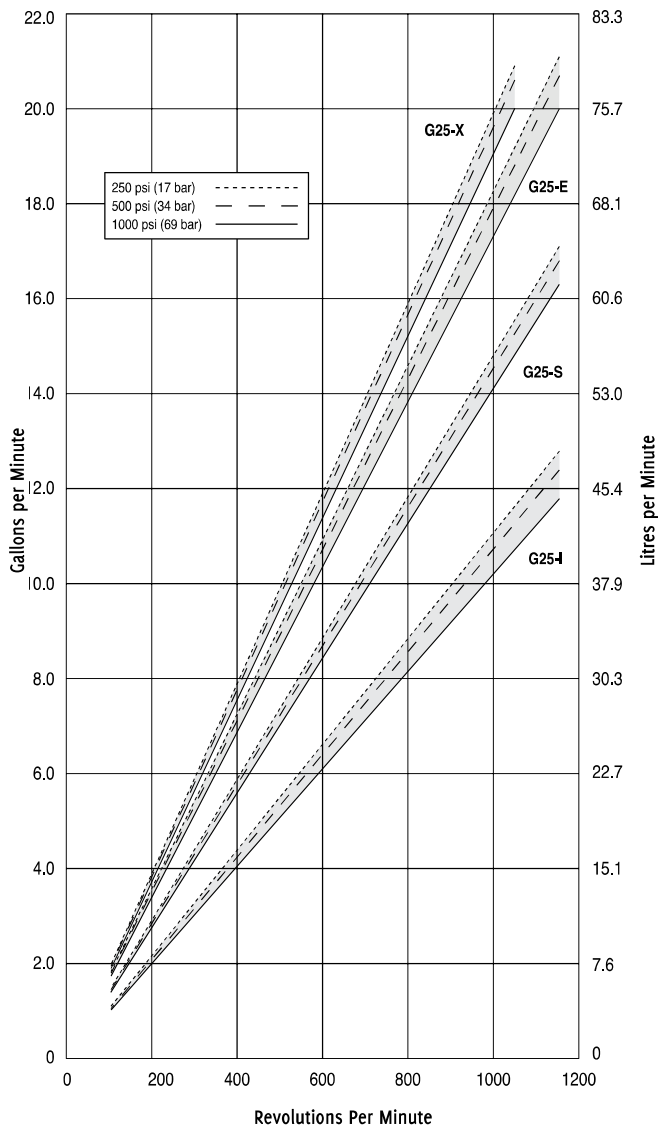

## G35 - API 674 option available

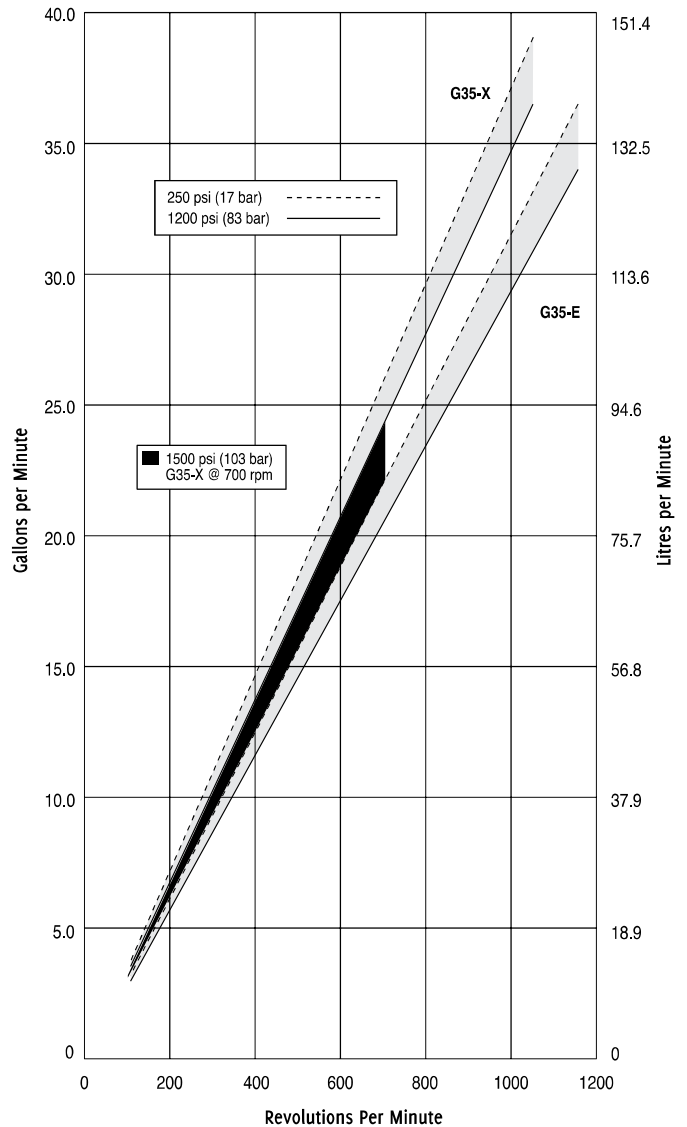

<b>Maximum Particle Size</b>	1.5mm @ 5-10% max. concentration
<b>Inlet Port</b>	1-1/2 inch BSPT (NPT option available)
<b>Discharge Port</b>	1 inch BSPT (NPT option available)
<b>Shaft Diameter</b>	1-1/8 inch (28.58 mm)
<b>Shaft Rotation</b>	Bi-directional
<b>Weight</b>	
Metallic Heads:	56.8 kg
Non-Metallic Heads:	40.9 kg

<b>Maximum Particle Size</b>	1.5mm @ 5-10% max. concentration
<b>Inlet Port</b>	2-1/2 inch BSPT (NPT option available) or 3 inch SAE flange
<b>Discharge Port</b>	1-1/4 inch BSPT (NPT option available) or 1-1/4 inch SAE flange
<b>Shaft Diameter</b>	2 inch (50.8 mm)
<b>Shaft Rotation</b>	Bi-directional
<b>Weight</b>	109 kg

### Calculating Required Horsepower (kW)\*

$$\frac{50 \times \text{rpm}}{63,000} + \frac{\text{gpm} \times \text{psi}}{1,460} = \text{electric motor HP}^*$$

$$\frac{50 \times \text{rpm}}{84,428} + \frac{\text{l/min} \times \text{bar}}{511} = \text{electric motor kW}^*$$

### Calculating Required Horsepower (kW)\*

$$\frac{100 \times \text{rpm}}{63,000} + \frac{\text{gpm} \times \text{psi}}{1,460} = \text{electric motor HP}^*$$

$$\frac{100 \times \text{rpm}}{84,428} + \frac{\text{l/min} \times \text{bar}}{511} = \text{electric motor kW}^*$$

\* rpm equals pump shaft rpm. HP/kW is required application power. Use caution when sizing motors with variable speed drives.

Note: For the low flow cams (B, G, I), a 1 bar pressurised inlet feed must be used. Performance specifications are guidelines only.

# Hydra-Cell® G Series Performance Graphs and Specifications

**G66** - API 674 option available

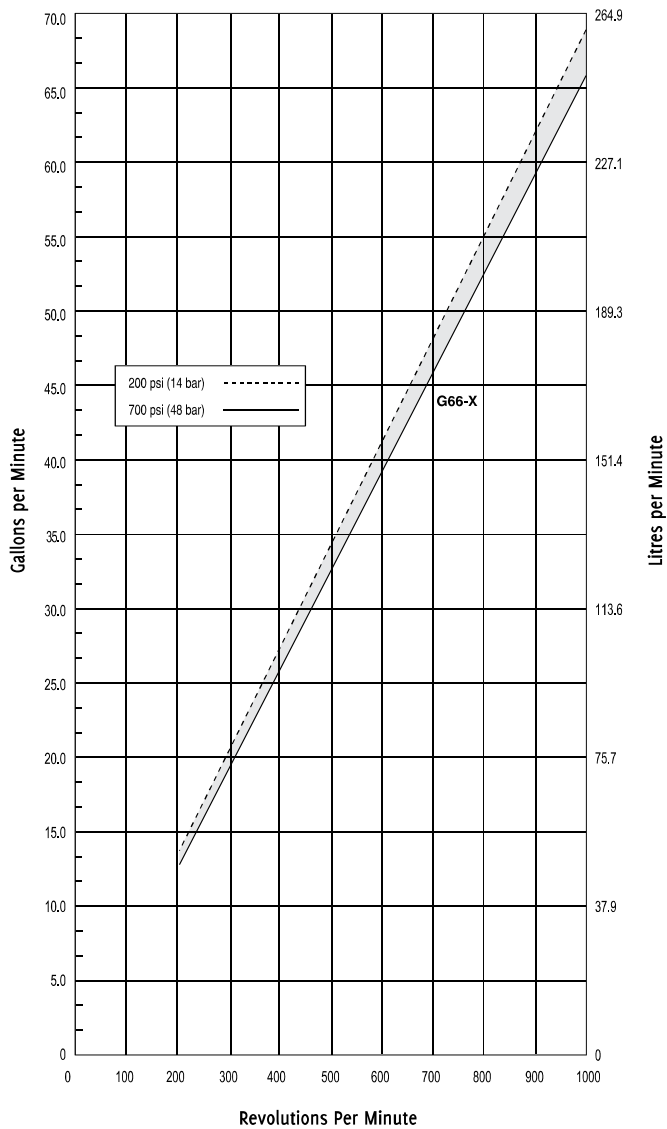

<b>Maximum Particle Size</b>	0.8mm
<b>Inlet Port</b>	3 inch BSPT (NPT option available) 2-1/2 inch SAE J518 flange (Non-metallic) 3 inch SAE J518 flange (Metallic)
<b>Discharge Port</b>	1-1/2 inch BSPT (NPT option available) 1-1/2 inch SAE flange
<b>Shaft Diameter</b>	3 inch SAE J518 flange (Metallic)
<b>Shaft Rotation</b>	Bi-directional
<b>Weight</b>	
Metallic Heads:	226 kg
Non-Metallic Heads:	133 kg

## Calculating Required Horsepower (kW)\*

$$\frac{100 \times \text{rpm}}{63,000} + \frac{\text{gpm} \times \text{psi}}{1,460} = \text{electric motor HP}^*$$

$$\frac{100 \times \text{rpm}}{84,428} + \frac{\text{l/min} \times \text{bar}}{511} = \text{electric motor kW}^*$$

\* rpm equals pump shaft rpm. HP/kW is required application power. Use caution when sizing motors with variable speed drives.

Note: For the low flow cams (B, G, I), a 1 bar pressurised inlet feed must be used. Performance specifications are guidelines only.



# C Series Valves Selection Guide

## Pressure Regulating Valves



C20 Series



C46 Series



C60 series  
(Seal-less Valves)

## Air Bleed Priming Valves



C80 Series

### Performance Advantages

- Accurate and repeatable
- Adjustable
- Immediate response
- Smooth, chatter-free bypass
- No external springs or moving parts
- Flow-through design with minimal pressure surge
- Heavy-duty construction - made in the USA

### Design Advantages

Tapered design of the C20 Series valves plunger.



### Seal-less Diaphragm

C60 Series valves feature a seal-less diaphragm with a tapered plunger, making the valves ideal for high-pressure requirements and handling dirty fluids.



# Hydra-Cell® T and Q Series Seal-less Pumps



T100 Low Pressure



T100 Medium Pressure



T100 High Pressure



Q155 Low Pressure



Q155 Medium Pressure

# Hydra-Cell® Flow Capacities and Pressure Ratings

## T Series Seal-less Pumps

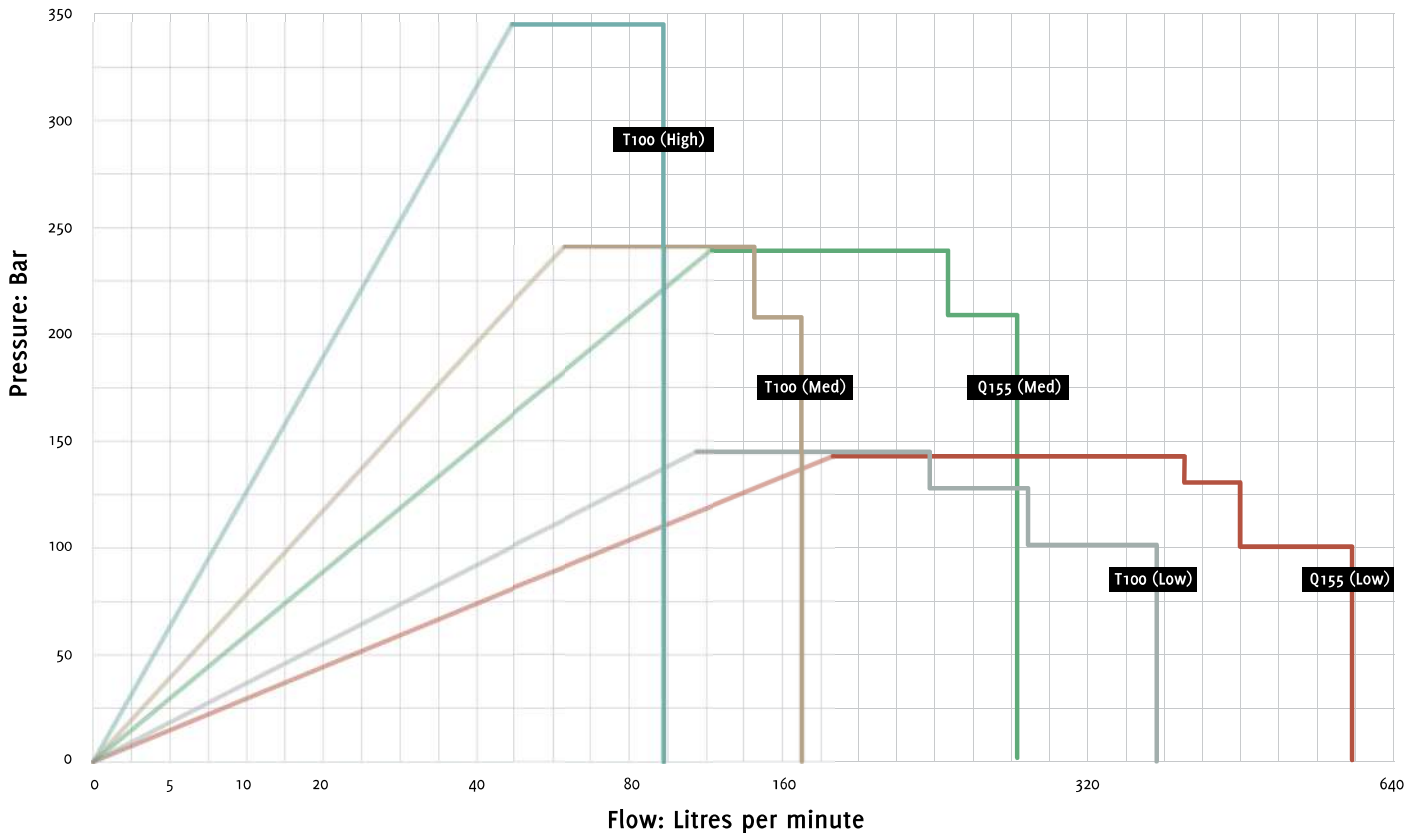

The graph above displays the maximum flow capacity at a given pressure for each model series. The table below lists the maximum flow capacity and maximum pressure capability of each model series.

Please Note: Some models do not achieve maximum flow at maximum pressure. Refer to the individual model specifications in this section for precise flow and pressure capabilities by specific pump configuration.

Model	Maximum Capacity l/min	Maximum Discharge Pressure bar	Maximum Operating Temperature °C <sup>1</sup>	Maximum Inlet Pressure bar
		Metallic	Metallic	
T100E	366	103	82°	34
T100F	290	128	82°	34
T100H	258	145	82°	34
T100K	170	207	82°	34
T100M	144	241	82°	34
T100S	98	345	82°	34
Q155E	595	103	82°	34
Q155F	490	128	82°	34
Q155H	421	145	82°	34
Q155K	295	207	82°	34
Q155M	246	241	82°	34

<sup>1</sup> Consult factory for correct component selection for temperatures from 160°F (71°C) to 250°F (121°C).



# Hydra-Cell® T Series Performance Graphs and Specifications

API 674 option available

## T100S

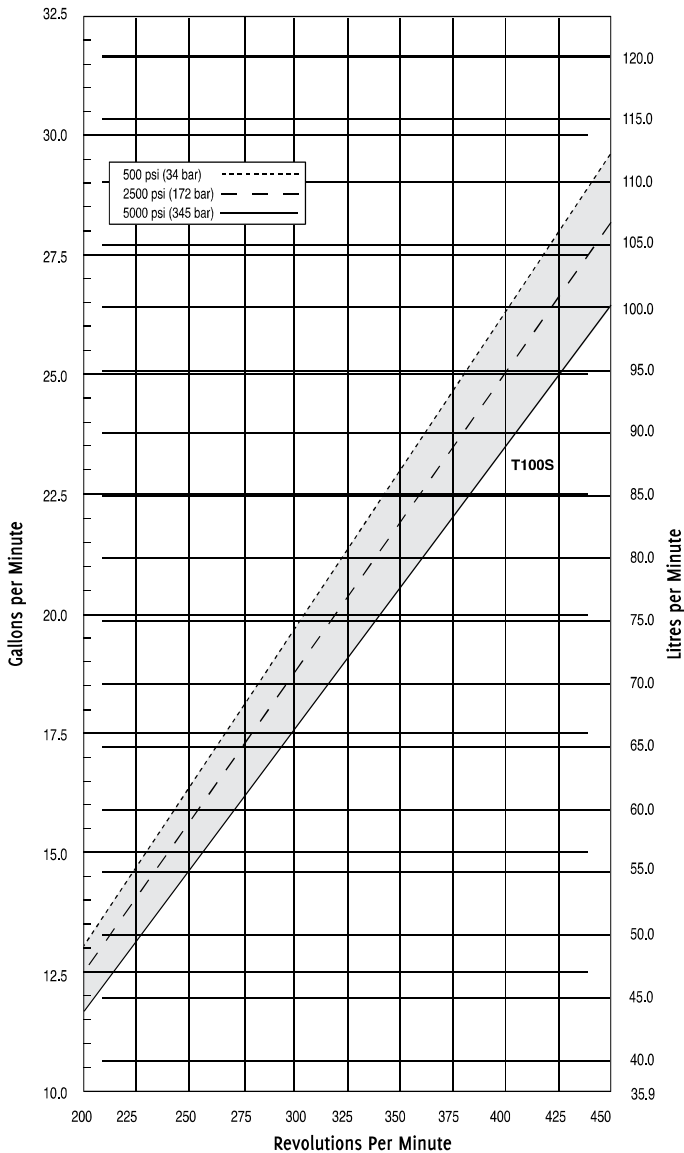

## T100K and T100M

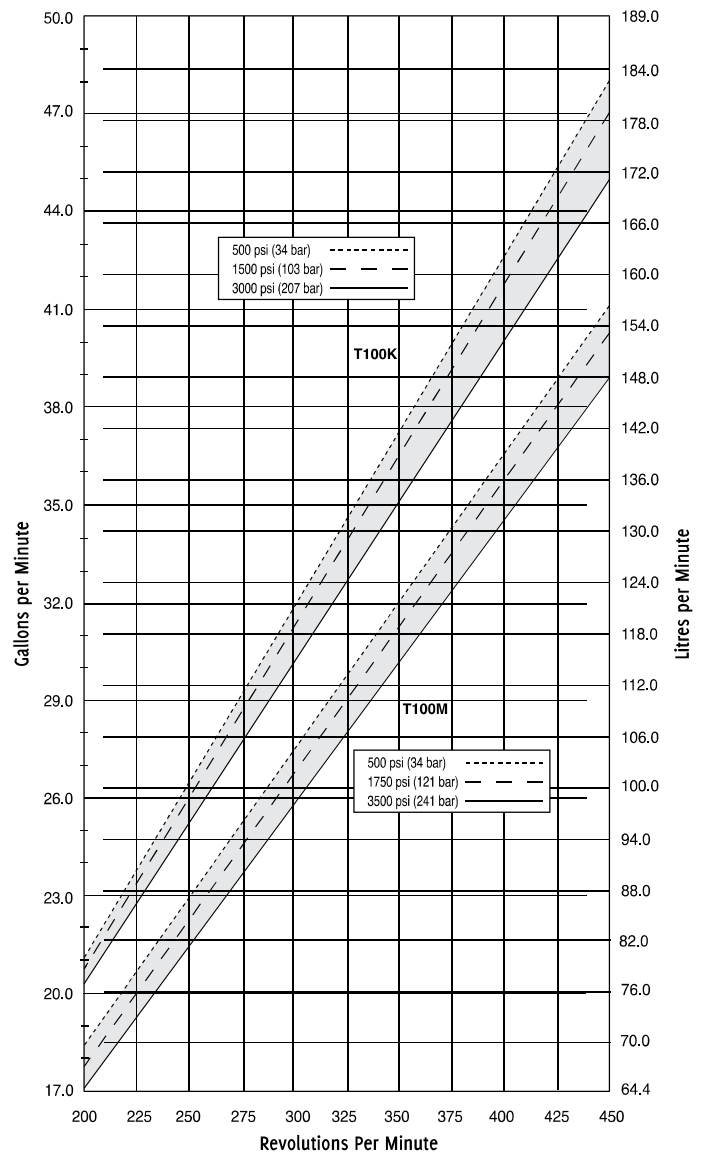

Maximum Particle Size	0.8mm
Inlet Port	Two 2 inch 300 lbs ANSI FF flange
Discharge Port	Two 1-1/4 inch, 2,500 lbs ANSI RTJ flange
Input Shaft	Left or right side
Shaft Diameter	76.2mm
Shaft Rotation	Bi-directional
Weight	499 kg

Maximum Particle Size	0.8mm
Inlet Port	Two 3-1/2 inch 300 lbs RF ANSI or 2-1/2 inch NPT
Discharge Port	Two 1-1/4 inch, 2,500 lbs RTJ ANSI or 1-1/2 inch NPT
Input Shaft	Left or right side
Shaft Diameter	76.2mm
Shaft Rotation	Bi-directional
Weight	499 kg

### Calculating Required Horsepower (kW)\*

$$\frac{\text{gpm} \times \text{psi}}{1,460} = \text{electric motor HP}^*$$

$$\frac{\text{l/min} \times \text{bar}}{511} = \text{electric motor kW}^*$$

### Calculating Required Horsepower (kW)\*

$$\frac{\text{gpm} \times \text{psi}}{1,460} = \text{electric motor HP}^*$$

$$\frac{\text{l/min} \times \text{bar}}{511} = \text{electric motor kW}^*$$

\* rpm equals pump shaft rpm. HP/kW is required application power. Use caution when sizing motors with variable speed drives.

Performance specifications are guidelines only.

For maximum pressure performance at low RPM below 200, which is outside the performance curve, consult factory.

# Hydra-Cell® T Series Performance Graphs and Specifications

API 674 option available

## T100E, T100F and T100H

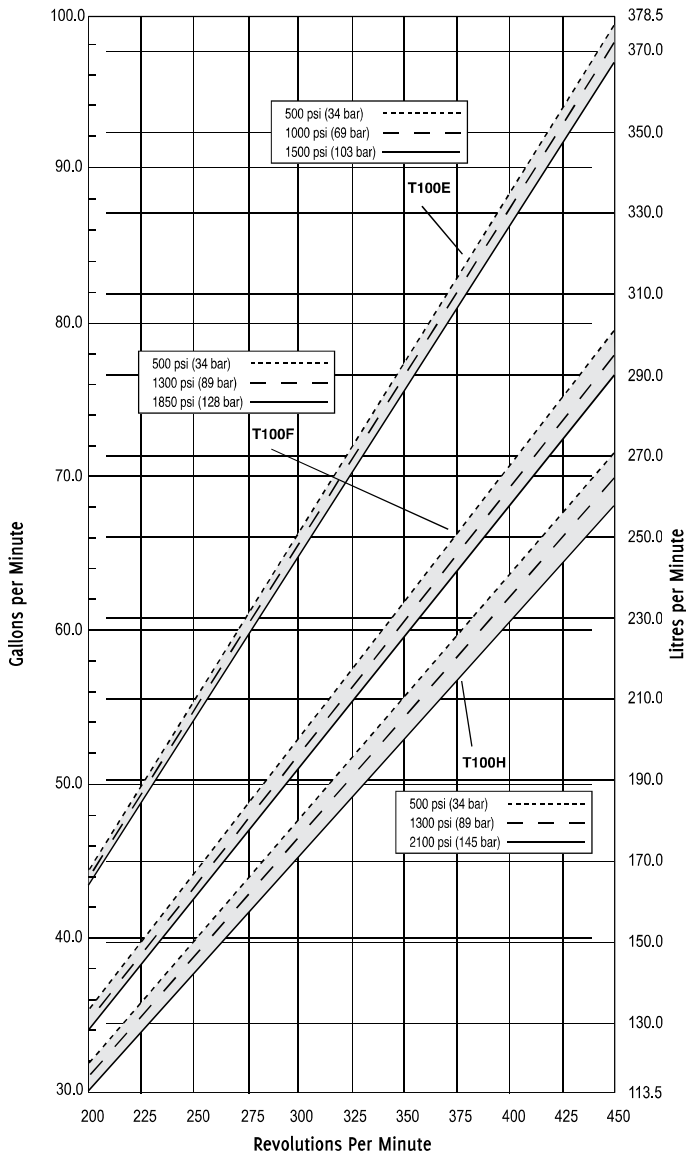

Maximum Particle Size	0.8mm
Inlet Port	Two 3-1/2 inch 300 lbs ANSI RF Flange
Discharge Port	Two 2 inch, 900 lbs ANSI RF Flange
Input Shaft	Left or right side
Shaft Diameter	76.2mm
Shaft Rotation	Bi-directional
Weight	499 kg

### Calculating Required Horsepower (kW)\*

$$\frac{\text{gpm} \times \text{psi}}{1,460} = \text{electric motor HP}^*$$

$$\frac{\text{l/min} \times \text{bar}}{511} = \text{electric motor kW}^*$$

\* rpm equals pump shaft rpm. HP/kW is required application power. Use caution when sizing motors with variable speed drives.

Performance specifications are guidelines only.

For maximum pressure performance at low RPM below 200, which is outside the performance curve, consult factory.

# Hydra-Cell® Q Series Performance Graphs and Specifications

API 674 option available

## Q155E, Q155F and Q155H

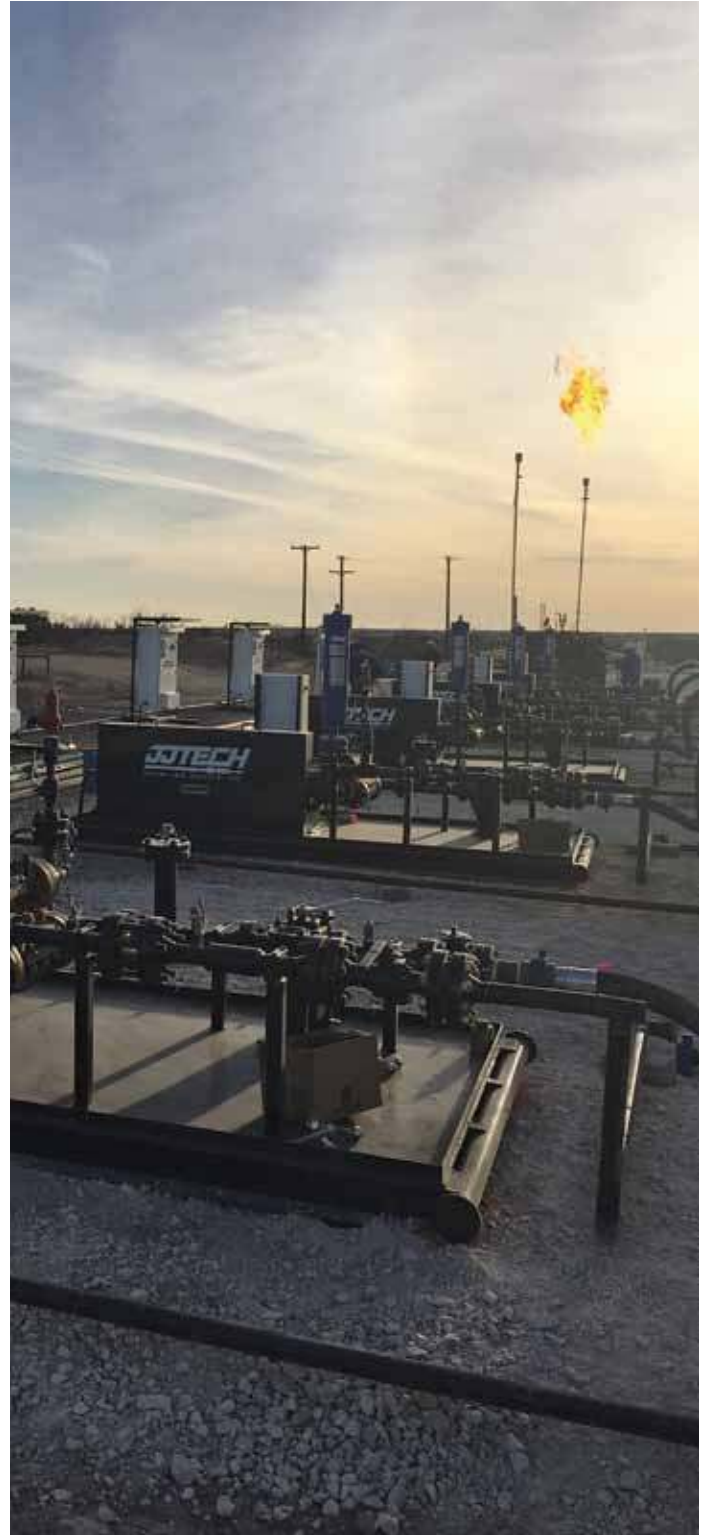
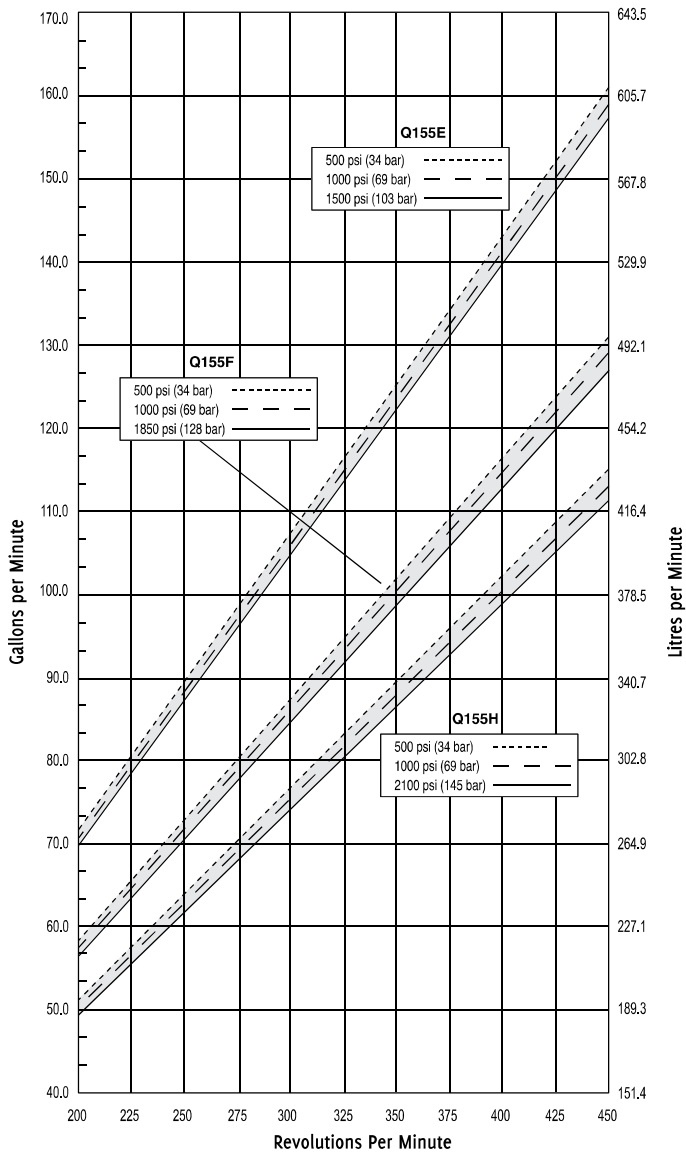

<b>Maximum Particle Size</b>	0.8mm
<b>Inlet Port</b>	Weld On: 4 inch / SCH. 40 or 4 inch NPT
<b>Discharge Port</b>	Weld On: 3 inch / SCH. 80 or 3 inch NPT
<b>Input Shaft</b>	Left or right side
<b>Shaft Diameter</b>	3 inch (76.2mm)
<b>Shaft Rotation</b>	Bi-directional
<b>Weight</b>	771 kg

### Calculating Required Horsepower (kW)\*

$$\frac{\text{gpm} \times \text{psi}}{1,460} = \text{electric motor HP}^*$$

$$\frac{\text{l/min} \times \text{bar}}{511} = \text{electric motor kW}^*$$

\* rpm equals pump shaft rpm. HP/kW is required application power. Use caution when sizing motors with variable speed drives.

Performance specifications are guidelines only.

For maximum pressure performance at low RPM below 200, which is outside the performance curve, consult factory.



# Hydra-Cell® Q Series Performance Graphs and Specifications

API 674 option available

## Q155K and Q155M

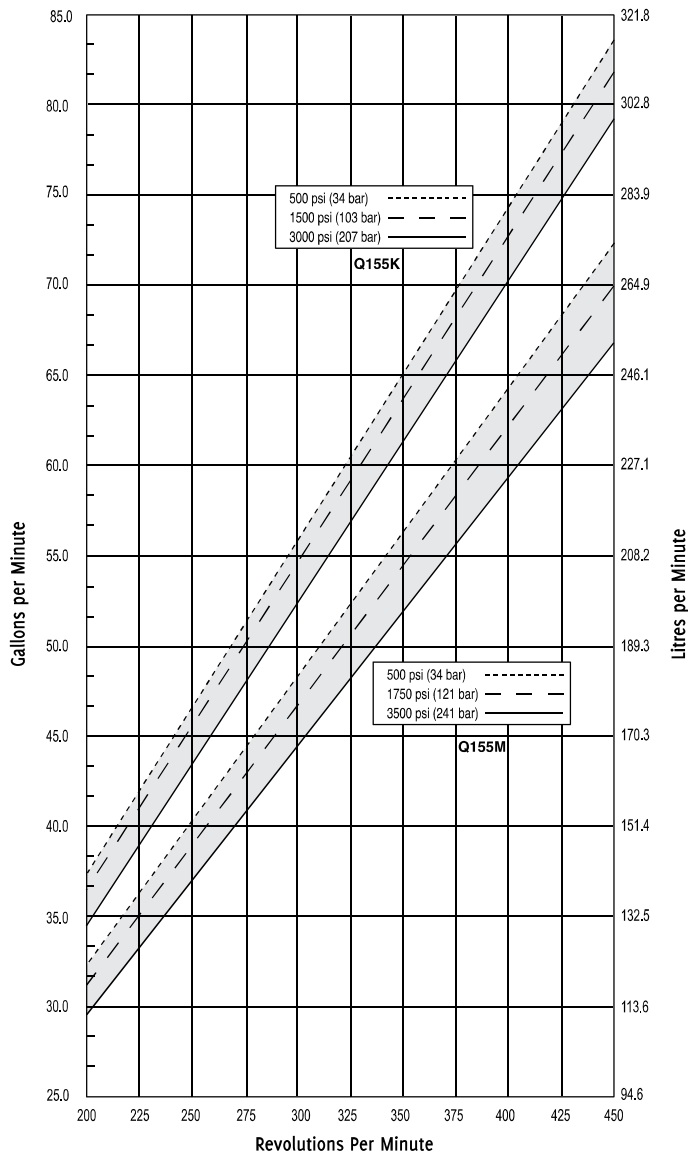

Maximum Particle Size	0.8mm
Inlet Port	Weld On: 4 inch / SCH. 40 or 4 inch NPT
Discharge Port	Weld On: 2 inch / SCH. 160 or 2 inch NPT
Input Shaft	Left or right side
Shaft Diameter	3 inch (76.2mm)
Shaft Rotation	Bi-directional
Weight	771 kg

### Calculating Required Horsepower (kW)\*

$$\frac{\text{gpm} \times \text{psi}}{1,460} = \text{electric motor HP}^*$$

$$\frac{\text{l/min} \times \text{bar}}{511} = \text{electric motor kW}^*$$

\* rpm equals pump shaft rpm. HP/kW is required application power. Use caution when sizing motors with variable speed drives.

Performance specifications are guidelines only.

For maximum pressure performance at low RPM below 200, which is outside the performance curve, consult factory.

# Hydra-Cell® Dosing Range Performance Pumps



G22 Dosing



G13 Dosing



G04 Dosing



G10 Dosing



G15 Dosing



G25 Dosing



G35 Dosing

# Hydra-Cell® Flow Capacities & Pressure Ratings

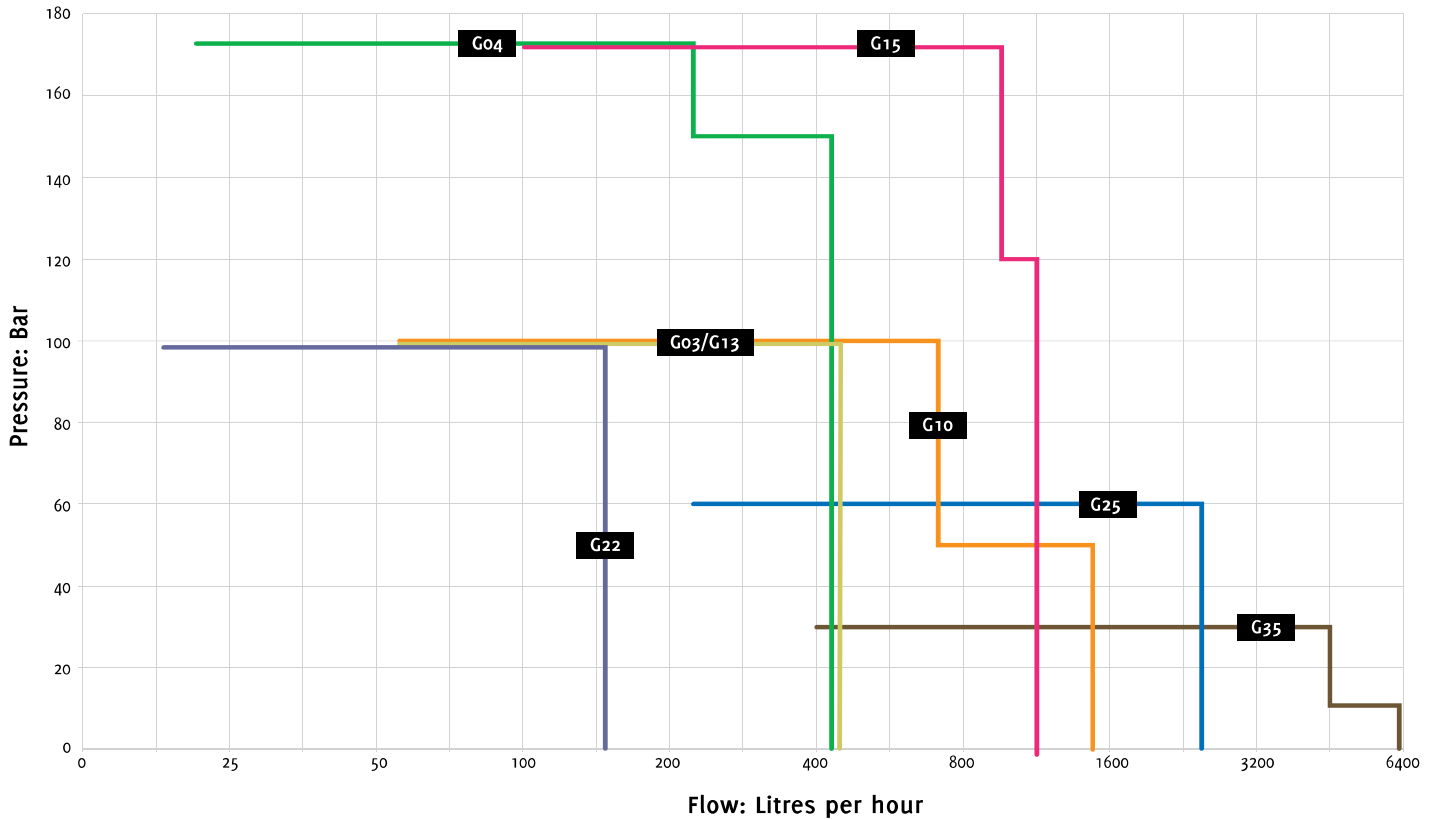

Model	Adjustable Flow Range		Maximum Discharge Pressure bar		Maximum Operating Temperature °C <sup>2</sup>		Maximum Inlet Pressure bar
	Minimum Capacity l/hr	Maximum Capacity l/hr	Non-Metallic <sup>1</sup>	Metallic	Non-Metallic	Metallic	
G22 - M6L	4.2	50	24	30	60°	121°	17
G22 - M4L	6.6	78	24	30	60°	121°	17
G22 - M2L	13.2	156	24	30	60°	121°	17
G22 - M6H	4.2	50	24	100	60°	121°	17
G22 - M4H	6.6	78	24	100	60°	121°	17
G22 - M2H	13.2	156	24	100	60°	121°	17
G13 - M2L	38	462	N/A	20	N/A	121°	17
G13 - M4L	19	230	N/A	20	N/A	121°	17
G13 - M2M	38	462	N/A	60	N/A	121°	17
G03 - M2H	38	462	24	100	60°	121°	17
G04 - M2M	38	452	N/A	150	N/A	121°	34
G04 - M4H	19	226	N/A	172	N/A	121°	34
G10 - M2L	120	1470	24	20	60°	121°	17
G10 - M2M	120	1470	24	50	60°	121°	17
G10 - M4L	60	732	24	20	60°	121°	17
G10 - M4H	60	732	24	100	60°	121°	17
G15 - M4M	100	1200	N/A	120	60°	121°	34
G15 - M4H	100	1000	N/A	150	60°	121°	34
G25 - M4L	216	2600	24	20	60°	121°	17
G25 - M4M	216	2600	24	60	60°	121°	17
G35 - M4L	396	4800	N/A	30	N/A	121°	34
G35 - M2L	792	6360	N/A	10	N/A	121°	34

1 24 bar maximum with PVDF (Kynar®) liquid end; 17 bar maximum with Polypropylene liquid end.

2 Consult factory for correct component selection for temperatures from 160°F (71°C) to 250°F (121°C).

3 Refer to G Series data sheets for relevant material selections





MT8



P100



P200



P300



P400



P500



P600

# Hydra-Cell® Flow Capacities & Pressure Ratings

## MT8 and P Series Electronic Precision Metering Pumps

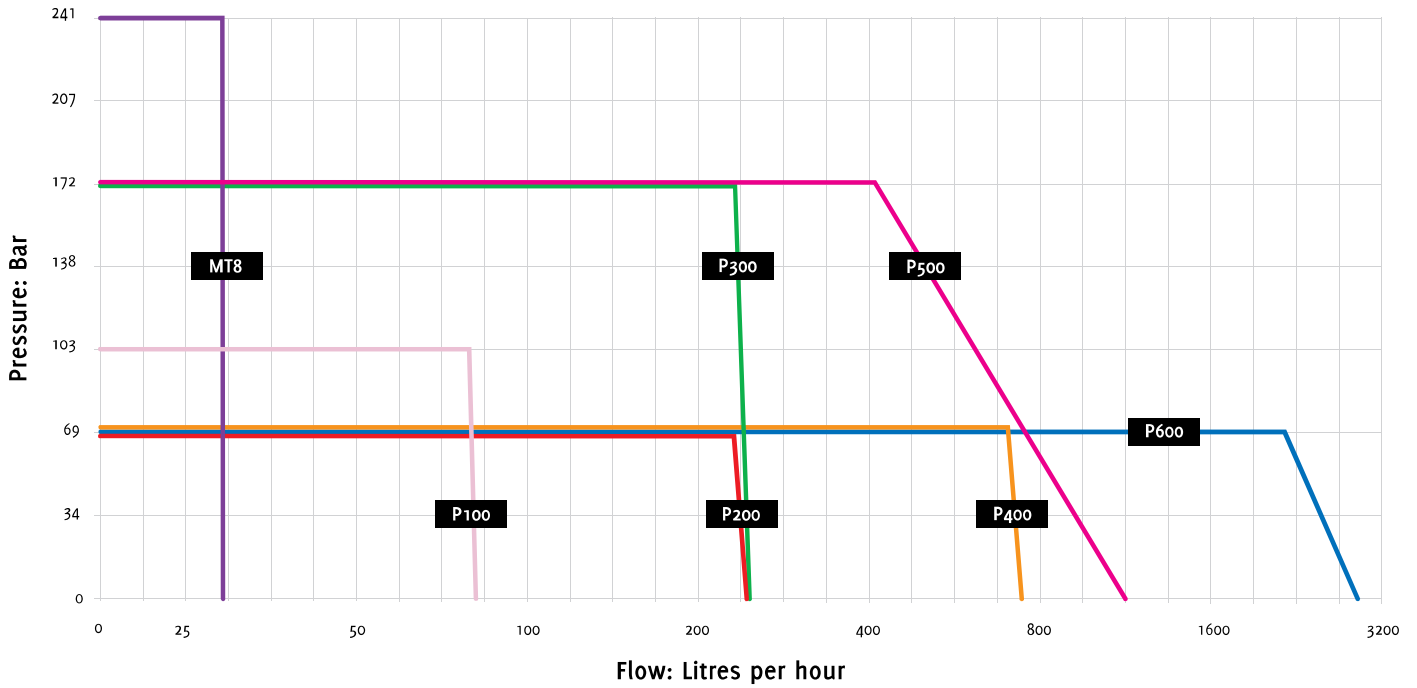

Model <sup>1</sup>	Maximum Capacity l/hr	Maximum Discharge Pressure bar		Maximum Operating Temperature °C <sup>3</sup>		Maximum Inlet Pressure bar
		Non-Metallic <sup>2</sup>	Metallic	Non-Metallic <sup>2</sup>	Metallic	
MT8	30	N/A	241	N/A	121°	17
P100	85	24	103	60°	121°	17
P200	255	24	69	60°	121°	17
P300	257	N/A	172	N/A	121°	34
P400	766	24	69	60°	121°	17
P500	1244	N/A	172	N/A	121°	34
P600	2808	24	69	60°	121°	17

<sup>1</sup> Ratings are for X-Cam design

<sup>2</sup> 24 bar maximum with PVDF (Kynar®) liquid end; 17 bar maximum with Polypropylene liquid end.

<sup>3</sup> Consult factory for correct component selection for temperatures above 71°C

## Hydra-Cell® MT8 and P Series Pumps Exceed API 675 Performance Standards

Hydra Cell Metering Solutions pumps meet or exceed API 675 performance standards for Steady-State Accuracy ( $\pm 1\%$ ), Linearity ( $\pm 3\%$ ) and Repeatability ( $\pm 3\%$ ).

# Hydra-Cell® Seal-less Metering Pumps Flow Capacities and Pressure Ratings



## MT8

**For Synchronous Speed, Self-Cooled Motors**  
L/hr Maximum Flow at Designated Pressure

L/hr All Pumps				Pump RPM	Gear Ratio	Motor RPM
34 Bar	103 Bar	172 Bar	241 Bar			
1.49	1.36	1.23	1.08	15.5	100:1	1500
1.85	1.68	1.52	1.35	18.75	80:1	
2.45	2.22	2.01	1.79	25	60:1	
3.03	2.75	2.51	2.26	30	50:1	
3.72	3.44	3.11	2.81	37.5	40:1	
5.03	4.54	4.13	3.72	50	30:1	
7.30	6.65	6.08	5.46	75	20:1	
14.71	13.44	12.13	10.83	150	10:1	
19.44	17.55	15.99	14.10	200	7.5:1	
29.16	26.33	23.12	20.63	300	5:1	

Required Motor kW

0.37

The above motor kW are based on ambient temperature conditions up to 25c°  
For ambient temperatures above 25c°, please consult Wanner International.

**For 10:1 Turndown, Self-Cooled Motors**  
L/hr Maximum Flow at Designated Pressure

L/hr All Pumps				Pump RPM	Gear Ratio	Motor RPM
34 Bar	103 Bar	172 Bar	241 Bar			
1.49	1.36	1.23	1.08	15.5	100:1	1500
1.85	1.68	1.52	1.35	18.75	80:1	
2.45	2.22	2.01	1.79	25	60:1	
3.03	2.75	2.51	2.26	30	50:1	
3.72	3.44	3.11	2.81	37.5	40:1	
5.03	4.54	4.13	3.72	50	30:1	
7.30	6.65	6.08	5.46	75	20:1	
14.71	13.44	12.13	10.83	150	10:1	
19.44	17.55	15.99	14.10	200	7.5:1	
29.16	26.33	23.12	20.63	300	5:1	

Required Motor kW

0.18    0.25    0.37    0.55

The above motor kW are based on ambient temperature conditions up to 25c°  
For ambient temperatures above 25c°, Force-Cooled Motors must be used.

<b>Maximum Particle Size</b>	0.2mm @ 40% max. concentration
<b>Inlet Port</b>	1/4 inch BSPT or NPT
<b>Discharge Port</b>	1/4 inch BSPT or NPT
<b>Weight (less motor)</b>	
Metallic head:	37 kg (82 lbs)

<b>Maximum Particle Size</b>	0.2mm @ 40% max. concentration
<b>Inlet Port</b>	1/4 inch BSPT or NPT
<b>Discharge Port</b>	1/4 inch BSPT or NPT
<b>Weight (less motor)</b>	
Metallic head:	37 kg (82 lbs)

Performance specifications are guidelines only.

Please note: Systems vary. The MT8 pump must be calibrated once installed to ensure optimum performance.  
The API 675 Performance Standard is achievable for flow rates as low as 0.227 L/hr. Please contact the factory for assistance.



# Hydra-Cell® Seal-less Metering Pumps Flow Capacities and Pressure Ratings



## P100

**For Synchronous Speed, Self-Cooled Motors**  
L/hr Maximum Flow at Designated Pressure

L/hr All Pumps		L/hr Metallic Pump Heads Only			Pump RPM	Gear Ratio	Motor RPM
7 Bar	17 Bar	34 Bar	69 Bar	100 Bar			
3.4	3.4	3.3	3.2	N/A	25	60:1	1500
4.1	4.1	4.0	3.9	N/A	30	50:1	
5.1	5.1	5.1	4.8	4.7	37.5	40:1	
6.9	6.9	6.8	6.5	6.3	50	30:1	
8.3	8.3	8.1	7.8	7.6	60	25:1	
10.5	10.4	10.2	9.8	9.5	75	20:1	
14.0	13.9	13.6	13.1	12.7	100	15:1	
21.1	20.9	20.4	19.6	19.1	150	10:1	
28.2	27.9	27.3	26.2	25.5	200	7.5:1	
42.4	41.9	41.0	39.4	38.3	300	5:1	
56.6	55.9	54.6	52.5	51.1	400	7.5:1	
85.0	83.8	82.0	78.8	76.7	600	5:1	
							3000

Required Motor kW

0.18	0.25	0.37	0.55	0.75
------	------	------	------	------

The above motor kW are based on ambient temperature conditions up to 25c°  
For ambient temperatures above 25c°, please consult Wanner International.

**For 10:1 Turndown, Self-Cooled Motors**  
L/hr Maximum Flow at Designated Pressure

L/hr All Pumps		L/hr Metallic Pump Heads Only			Pump RPM	Gear Ratio	Motor RPM
7 Bar	17 Bar	34 Bar	69 Bar	100 Bar			
3.4	3.4	3.3	3.2	N/A	25	60:1	1500
4.1	4.1	4.0	3.8	N/A	30	50:1	
5.1	5.1	5.1	4.8	4.7	37.5	40:1	
6.9	6.9	6.8	6.5	6.2	50	30:1	
8.3	8.3	8.1	7.8	7.6	60	25:1	
10.5	10.4	10.2	9.8	9.5	75	20:1	
14.0	13.9	13.6	13.1	12.7	100	15:1	
21.1	20.9	20.4	19.6	19.1	150	10:1	
28.2	27.9	27.3	26.2	25.5	200	7.5:1	
42.4	41.9	41.0	39.4	38.3	300	5:1	
56.6	55.9	54.6	52.5	51.1	400	7.5:1	
85.0	83.8	82.0	78.8	76.7	600	5:1	
							3000

Required Motor kW

0.18	0.25	0.37	0.55	0.75	1.1
------	------	------	------	------	-----

The above motor kW are based on ambient temperature conditions up to 25c°  
For ambient temperatures above 25c°, Force-Cooled Motors must be used.

<b>Maximum Particle Size</b>	0.3mm @ 15% max. concentration
<b>Inlet Port</b>	1/2 inch BSPT
<b>Discharge Port</b>	3/8 inch BSPT
<b>Weight (less motor)</b>	
Metallic head:	9.7 kg (21.3 lbs)
Non-metallic head:	8.7 kg (19.2 lbs)

<b>Maximum Particle Size</b>	0.3mm @ 15% max. concentration
<b>Inlet Port</b>	1/2 inch BSPT
<b>Discharge Port</b>	3/8 inch BSPT
<b>Weight (less motor)</b>	
Metallic head:	9.7 kg (21.3 lbs)
Non-metallic head:	8.7 kg (19.2 lbs)

Performance specifications are guidelines only.

# Hydra-Cell® Seal-less Metering Pumps Flow Capacities and Pressure Ratings



## P200

### For Synchronous Speed, Self-Cooled Motors

L/hr Maximum Flow at Designated Pressure

L/hr All Pumps		L/hr Metallic Pump Heads Only		Pump RPM	Gear Ratio	Motor RPM
7 Bar	17 Bar	34 Bar	69 Bar			
10.6	10.5	10.2	9.9	25	60:1	1500
12.8	12.6	12.3	11.9	30	50:1	
16.0	15.8	15.5	15.0	37.5	40:1	
21.3	21.1	20.7	20.0	50	30:1	
25.6	25.3	24.8	24.1	60	25:1	
32.0	31.6	31.1	30.2	75	20:1	
42.6	42.2	41.5	40.3	100	15:1	
63.9	63.2	62.2	60.5	150	10:1	
85.1	84.3	83.0	80.8	200	7.5:1	
127.7	126.5	124.6	121.3	300	5:1	
170.3	168.7	166.1	161.8	400	7.5:1	3000
255.4	253.0	249.2	242.8	600	5:1	

Required Motor kW

0.18	0.37	0.75
------	------	------

The above motor kW are based on ambient temperature conditions up to 25c°  
For ambient temperatures above 25c°, please consult Wanner International.

### For 10:1 Turndown, Self-Cooled Motors

L/hr Maximum Flow at Designated Pressure

L/hr All Pumps		L/hr Metallic Pump Heads Only		Pump RPM	Gear Ratio	Motor RPM
7 Bar	17 Bar	34 Bar	69 Bar			
10.6	10.5	10.2	9.9	25	60:1	1500
12.8	12.6	12.3	11.9	30	50:1	
16.0	15.8	15.5	15.0	37.5	40:1	
21.3	21.1	20.7	20.0	50	30:1	
25.6	25.3	24.8	24.1	60	25:1	
32.0	31.6	31.1	30.2	75	20:1	
42.6	42.2	41.5	40.3	100	15:1	
63.9	63.3	62.2	60.5	150	10:1	
85.1	84.3	83.0	80.8	200	7.5:1	
127.7	126.5	124.6	121.3	300	5:1	
170.3	168.7	166.1	161.8	400	7.5:1	3000
255.4	253.0	249.2	242.8	600	5:1	

Required Motor kW

0.18	0.25	0.37	0.55	0.75	1.1
1.5					

The above motor kW are based on ambient temperature conditions up to 25c°  
For ambient temperatures above 25c°, Force-Cooled Motors must be used.

<b>Maximum Particle Size</b>	0.3mm @ 15% max. concentration
<b>Inlet Port</b>	1/2 inch BSPT
<b>Discharge Port</b>	3/8 inch BSPT
<b>Weight (less motor)</b>	
Metallic head:	19.0 kg (41.8 lbs)
Non-metallic head:	14.9 kg (32.8 lbs)

<b>Maximum Particle Size</b>	0.3mm @ 15% max. concentration
<b>Inlet Port</b>	1/2 inch BSPT
<b>Discharge Port</b>	3/8 inch BSPT
<b>Weight (less motor)</b>	
Metallic head:	19.0 kg (41.8 lbs)
Non-metallic head:	14.9 kg (32.8 lbs)

Performance specifications are guidelines only.

# Hydra-Cell® Seal-less Metering Pumps Flow Capacities and Pressure Ratings



## P300

**For Synchronous Speed, Self-Cooled Motors**  
L/hr Maximum Flow at Designated Pressure

L/hr Metallic Pump Heads Only				Pump RPM	Gear Ratio	Motor RPM
7 Bar	34 Bar	103 Bar	172 Bar			
10.2	10.0	9.5	8.6	25	60:1	1500
12.3	12.1	11.5	10.6	30	50:1	
15.6	15.4	14.5	13.5	37.5	40:1	
20.9	20.7	19.5	18.2	50	30:1	
25.2	24.9	23.5	22.1	60	25:1	
31.7	31.2	29.6	27.8	75	20:1	
42.4	41.7	39.6	37.4	100	15:1	
63.8	62.7	59.6	56.5	150	10:1	
85.3	83.7	79.6	75.6	200	7.5:1	
128.2	125.8	119.7	113.8	300	5:1	
171.1	167.8	159.7	152.0	400	7.5:1	3000
256.8	251.9	239.8	228.5	600	5:1	

Required Motor kW

0.18	0.37	0.55	0.75	1.1	1.5
------	------	------	------	-----	-----

The above motor kW are based on ambient temperature conditions up to 25c°  
For ambient temperatures above 25c°, please consult Wanner International.

**For 10:1 Turndown, Self-Cooled Motors**  
L/hr Maximum Flow at Designated Pressure

L/hr Metallic Pump Heads Only				Pump RPM	Gear Ratio	Motor RPM
7 Bar	34 Bar	103 Bar	172 Bar			
10.2	10.0	9.51	8.6	25	60:1	1500
12.3	12.1	11.53	10.6	30	50:1	
15.6	15.4	14.53	13.5	37.5	40:1	
20.9	20.7	19.54	18.2	50	30:1	
25.2	24.9	23.54	22.1	60	25:1	
31.7	31.2	29.55	27.8	75	20:1	
42.4	41.7	39.56	37.4	100	15:1	
63.8	62.7	59.59	56.5	150	10:1	
85.3	83.7	79.61	75.6	200	7.5:1	
128.2	125.8	119.7	113.8	300	5:1	
171.1	167.8	159.7	152.0	400	7.5:1	3000
256.8	251.9	239.8	228.5	600	5:1	

Required Motor kW

0.18	0.25	0.37	0.55	0.75	1.1
1.5	2.2	3.0			

The above motor kW are based on ambient temperature conditions up to 25c°  
For ambient temperatures above 25c°, Force-Cooled Motors must be used.

<b>Maximum Particle Size</b>	0.3mm @ 15% max. concentration
<b>Inlet Port</b>	1/2 inch BSPT
<b>Discharge Port</b>	1/2 inch BSPT
<b>Weight (less motor)</b>	24.7 kg (54.5 lbs)

<b>Maximum Particle Size</b>	0.3mm @ 15% max. concentration
<b>Inlet Port</b>	1/2 inch BSPT
<b>Discharge Port</b>	1/2 inch BSPT
<b>Weight (less motor)</b>	24.7 kg (54.5 lbs)

Performance specifications are guidelines only.



# Hydra-Cell® Seal-less Metering Pumps Flow Capacities and Pressure Ratings



## P400

**For Synchronous Speed, Self-Cooled Motors**  
L/hr Maximum Flow at Designated Pressure

L/hr All Pumps		L/hr Metallic Pump Heads Only		Pump RPM	Gear Ratio	Motor RPM
7 Bar	17 Bar	34 Bar	69 Bar			
30.4	29.3	26.8	20.4	25	60:1	1500
36.8	35.6	33.0	26.1	30	50:1	
46.2	45.1	42.2	35.4	37.5	40:1	
62.2	60.9	57.7	50.3	50	30:1	
75.0	73.6	70.1	62.3	60	25:1	
94.2	92.6	88.8	80.3	75	20:1	
126.2	124.2	119.9	110.2	100	15:1	
190.2	187.5	182.0	170.1	150	10:1	
254.2	250.8	244.2	230.0	200	7.5:1	
382.1	377.4	368.5	349.7	300	5:1	
510.0	503.9	492.8	469.5	400	7.5:1	3000
765.9	757.1	741.4	709.0	600	5:1	

Required Motor kW

0.18	0.37	0.55	0.75	1.1
1.5	2.2			

The above motor kW are based on ambient temperature conditions up to 25°C  
For ambient temperatures above 25°C, please consult Wanner International.

**For 10:1 Turndown, Self-Cooled Motors**  
L/hr Maximum Flow at Designated Pressure

L/hr All Pumps		L/hr Metallic Pump Heads Only		Pump RPM	Gear Ratio	Motor RPM
7 Bar	17 Bar	34 Bar	69 Bar			
30.4	29.3	26.8	20.4	25	60:1	1500
36.8	35.6	33.0	26.1	30	50:1	
46.2	45.1	42.2	35.4	37.5	40:1	
62.2	60.9	57.7	50.3	50	30:1	
75.0	73.6	70.1	62.3	60	25:1	
94.2	92.6	88.8	80.3	75	20:1	
126.2	124.2	119.9	110.2	100	15:1	
190.2	187.5	182.0	170.1	150	10:1	
254.2	250.8	244.2	230.0	200	7.5:1	
382.1	377.4	368.5	349.7	300	5:1	
510.0	503.9	492.8	469.5	400	7.5:1	3000
765.9	757.1	741.4	709.0	600	5:1	

Required Motor kW

0.18	0.25	0.37	0.55	0.75	1.1
1.5	2.2	3.0			

The above motor kW are based on ambient temperature conditions up to 25°C  
For ambient temperatures above 25°C, Force-Cooled Motors must be used.

<b>Maximum Particle Size</b>	0.8mm @ 5-10% max. concentration
<b>Inlet Port</b>	1 inch BSPT
<b>Discharge Port</b>	3/4 inch BSPT
<b>Weight (less motor)</b>	
Metallic head:	29.7 kg (65.5 lbs)
Non-metallic head	23.8 kg (52.5 lbs)

<b>Maximum Particle Size</b>	0.8mm @ 5-10% max. concentration
<b>Inlet Port</b>	1 inch BSPT
<b>Discharge Port</b>	3/4 inch BSPT
<b>Weight (less motor)</b>	
Metallic head:	29.7 kg (65.5 lbs)
Non-metallic head	23.8 kg (52.5 lbs)

Performance specifications are guidelines only.

# Hydra-Cell® Seal-less Metering Pumps Flow Capacities and Pressure Ratings



## P500

**For Synchronous Speed, Self-Cooled Motors**  
L/hr Maximum Flow at Designated Pressure

L/hr Metallic Pump Heads Only				Pump RPM	Gear Ratio	Motor RPM
7 Bar	34 Bar	103 Bar	172 Bar			
55.1	53.5	49.7	45.6	25	60:1	1500
66.2	64.4	60.3	55.8	30	50:1	
83.2	81.2	76.3	71.5	37.5	40:1	
111.3	108.7	102.9	97.2	50	30:1	
133.7	130.8	124.2	117.7	60	25:1	
167.3	163.9	156.1	148.5	75	20:1	
223.3	219.1	209.3	199.8	100	15:1	
335.3	329.5	315.7	302.4	150	10:1	
447.3	439.8	422.0	405.1	200	7.5:1	
671.4	660.1	634.8	N/A	300	5:1	
895.4	881.3	N/A	N/A	400	7.5:1	3000
1343.5	1322.7	N/A	N/A	600	5:1	

Required Motor kW

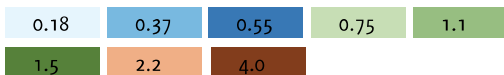

The above motor kW are based on ambient temperature conditions up to 25°C. For ambient temperatures above 25°C, please consult Wanner International.

**For 10:1 Turndown, Self-Cooled Motors**  
L/hr Maximum Flow at Designated Pressure

L/hr Metallic Pump Heads Only				Pump RPM	Gear Ratio	Motor RPM
7 Bar	34 Bar	103 Bar	172 Bar			
55.1	53.5	49.7	45.6	25	60:1	1500
66.2	64.4	60.3	55.8	30	50:1	
83.2	81.2	76.3	71.5	37.5	40:1	
111.3	108.7	102.9	97.2	50	30:1	
133.7	130.8	124.2	117.7	60	25:1	
167.3	163.9	156.1	148.5	75	20:1	
223.3	219.1	209.3	199.8	100	15:1	
335.3	329.5	315.7	N/A	150	10:1	
447.3	439.8	422.0	N/A	200	7.5:1	
671.4	660.1	N/A	N/A	300	5:1	
895.4	N/A	N/A	N/A	400	7.5:1	3000
1343.5	N/A	N/A	N/A	600	5:1	

Required Motor kW

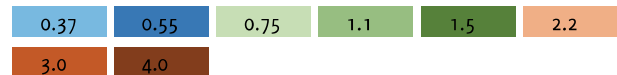

The above motor kW are based on ambient temperature conditions up to 25°C. For ambient temperatures above 25°C, Force-Cooled Motors must be used.

<b>Maximum Particle Size</b>	0.3mm @ 15% max. concentration
<b>Inlet Port</b>	1-1/4 inch BSPT
<b>Discharge Port</b>	3/4 inch BSPT
<b>Weight (less motor)</b>	88.5 kg (192.1 lbs)

<b>Maximum Particle Size</b>	0.3mm @ 15% max. concentration
<b>Inlet Port</b>	1-1/4 inch BSPT
<b>Discharge Port</b>	3/4 inch BSPT
<b>Weight (less motor)</b>	88.5 kg (192.1 lbs)

Performance specifications are guidelines only.

# Hydra-Cell® Seal-less Metering Pumps Flow Capacities and Pressure Ratings



## P600

**For Synchronous Speed, Self-Cooled Motors**  
L/hr Maximum Flow at Designated Pressure

L/hr All Pumps		L/hr Metallic Pump Heads Only		Pump RPM	Gear Ratio	Motor RPM
7 Bar	17 Bar	34 Bar	69 Bar			
115.1	113.9	111.1	104.9	25	60:1	1500
138.5	137.2	134.0	127.3	30	50:1	
173.5	172.0	168.4	161.4	37.5	40:1	
232.0	230.2	225.8	216.9	50	30:1	
278.9	276.7	271.7	261.2	60	25:1	
349.2	346.5	340.5	327.8	75	20:1	
466.3	462.7	455.2	438.6	100	15:1	
700.5	695.3	684.7	660.4	150	10:1	
934.7	927.9	914.1	882.2	200	7.5:1	
1403	1393	1373	1326	300	5:1	
1872	1858	1832	N/A	400	7.5:1	3000
2808	2788	N/A	N/A	600	5:1	

Required Motor kW

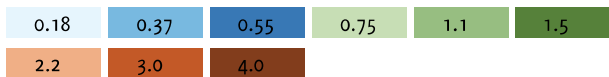

The above motor kW are based on ambient temperature conditions up to 25°C. For ambient temperatures above 25°C, please consult Wanner International.

<b>Maximum Particle Size</b>	1.5mm @ 5-10% max. concentration
<b>Inlet Port</b>	1-1/2 inch BSPT
<b>Discharge Port</b>	1 inch BSPT
<b>Weight (less motor)</b>	
Metallic head:	66.2 kg (146 lbs)
Non-metallic head	50.3 kg (111 lbs)

**For 10:1 Turndown, Self-Cooled Motors**  
L/hr Maximum Flow at Designated Pressure

L/hr All Pumps		L/hr Metallic Pump Heads Only		Pump RPM	Gear Ratio	Motor RPM
7 Bar	17 Bar	34 Bar	69 Bar			
115.1	113.9	111.1	104.9	25	60:1	1500
138.5	137.2	134.0	127.3	30	50:1	
173.5	172.0	168.4	161.4	37.5	40:1	
232.0	230.2	225.8	216.9	50	30:1	
278.9	276.7	271.7	261.2	60	25:1	
349.2	346.5	340.5	327.8	75	20:1	
466.3	462.7	455.2	438.6	100	15:1	
700.5	695.3	684.7	N/A	150	10:1	
934.7	927.9	914.1	N/A	200	7.5:1	
1403	1393	1373	N/A	300	5:1	
1872	1858	N/A	N/A	400	7.5:1	3000
2808	N/A	N/A	N/A	600	5:1	

Required Motor kW



The above motor kW are based on ambient temperature conditions up to 25°C. For ambient temperatures above 25°C, Force-Cooled Motors must be used.

<b>Maximum Particle Size</b>	1.5mm @ 5-10% max. concentration
<b>Inlet Port</b>	1-1/2 inch BSPT
<b>Discharge Port</b>	1 inch BSPT
<b>Weight (less motor)</b>	
Metallic head:	66.2 kg (146 lbs)
Non-metallic head	50.3 kg (111 lbs)

Performance specifications are guidelines only.



# Hydra-Cell® S Series Solenoid Metering Pumps

The S Series pumps provide an economical choice for chemical injection in metering applications.

Solenoid driven, the S pumps feature a wide discharge-volume range, extensive choice of liquid end materials, various control functions, and a wide voltage range.

Materials of construction choices and versatile design options result in pumps perfected for specific applications including general chemicals, high-pressure boiler, high-viscosity fluids, outgassing and more.

- “Eco-friendly” environmentally sound operation is standard with SP, ST & SA models - this feature can lower power consumption up to 55%
- Double-ball check valve ensures accurate metering and reduces the chance of water hammer
- Model available with a pump head that can be moved in three directions to provide flexibility of installation
- Dust-proof and wash down capable (IP65) - ideal for indoor or outdoor use
- Pump housing is molded from high-impact PP0, an engineered thermoplastic that provides dimensional stability and excellent resistance to heat

Flow Rate	SM Series Models	SP/ST/SA Series Models
30 ml/min	SM030	SP/ST/SA-030
60 ml/min	SM060	SP/ST/SA-060
100 ml/min	SM100	SP/ST/SA-100
200 ml/min	N/A	SP/ST/SA-200
<b>With Relief Valve</b>		
30 ml/min	SM03R	SP/ST/SA-03R
60 ml/min	SM06R	SP/ST/SA-06R
100 ml/min	SM10R	SP/ST/SA-10R



Spare parts kits to help extend service life.



SM030CAS manual control with stroke speed dial.



SP060HVS digital with pulse-in control.



ST03RPES digital with pulse-in control and timer.



SA03RPES digital with pulse-in and analog-in.

Solution tanks for S Series pumps are available in various sizes and capacities.



# Hydra-Cell® Metering and Dosing Control Options

For G Series, P-Series and MT8 pumps

## Electronic Flow Rate Adjustment For Local Control

- ATEX Dust Zone 21 (Ex tb III C T125c Db)
- IP66 Standard
- Various flow rate adjustments options including:
  - On-board potentiometer(s)
  - On-board key-pad controller with flow rate display
  - Removable, hand-held key-pad controller for authorised personnel only



## Control Freak For Sophisticated Local Control

- Option available to control up to 6 x Hydra-Cell pumps with one Hydra-Cell “Control Freak”
- Multiple Variable Frequency Drive (VFD) options
- Enables programming for flow rate or totalisation
- Allows up to 10 x separate batch sequences
- Built-in Calibration mode
- Wireless option available



## Mechanical Flow Rate Adjustment For Local Control

- ATEX Zone 1
- Linear fine adjustment scale on hand-wheel
- High reliability due to frictionless design
- Option to fit a mechanical lock to prevent unauthorised flow rate change



On-board keypad control

Hand-held keypad control



# Hydra-Cell® Pumps Accessories and Options

## Pump & Motor Adaptors:



## Hydra-Oil Lubricants:

Hydra-Oil is specially formulated to maximize performance of Hydra-Cell pumps.

- Reduce wear
- Withstand extreme temperature changes
- Improve pump performance
- Extend pump life
- Maintain consistent viscosity
- Withstand extreme pressures



## Tool Kits:

Customized for your specific pump model, Hydra-Cell Tool Kits provide specialty tools to facilitate maintenance and servicing of your Hydra-Cell pump. Each kit is packaged in a durable plastic case and includes a shaft rotator, valve seat remover, plunger guide lifter, plunger holder, protector seal, seal inserter, and assembly studs.



## Back Pressure & Pressure Relief Valves:

Back pressure valves help ensure that your Hydra-Cell pump provides accurate and predictable flow. Pressure relief valves protect your pump and system from over-pressure situations.



## Pulsation Dampeners:

Pulsation dampeners protect your pumping system and its components by removing virtually all hydraulic shock and vibration resulting from the reciprocating stroking action of a positive displacement pump.



They control pulsations by allowing fluid to enter a wetted chamber of the dampener during the discharge stroke. This displaces a flexible bladder, which compresses gas in an air chamber, thus absorbing the shock. During the inlet stroke, liquid pressure decreases as the dampener gas expands, allowing fluid to re-enter the process line.

Bladders are available in Neoprene, Buna-N, EPDM, FKM, and PTFE (except where noted) to match Hydra-Cell pump diaphragm materials.

- Produces steady fluid flow up to 99% pulsation- and vibration-free
- Protects pipes, valves, fittings, meters, and in-line instrumentation from destructive pulsations, cavitation, and water hammer
- Creates steady and continuous flow when dosing, blending, or proportioning additives
- Ensures accuracy, longevity, and repeatability of in-line meters
- Enables uniform application of material in spraying and coating systems
- Reduces product agitation, foaming, splashing, and degradation of products Steel

## Calibration Cylinders:

Calibration cylinders verify the flow rate of a Hydra-Cell P Series metering pump, providing a visual indicator that the system is operating within the required parameters of performance and accuracy.



## Service Kits:

Convenient replacement part kits for all models of Hydra-Cell pumps are prepackaged with all necessary components to make pump service quick and easy. Three types of kits are available depending on the level of replacement service required:

- Diaphragm Kit
- Valve Kit
- Complete Fluid-end Kit

Every kit has the correct components matching your specific pump configuration and materials (based on your original model number designed in Order Code Digits 7, 8, 9, 10 & 11).





# Hydra-Cell® Worldwide Sales and Service

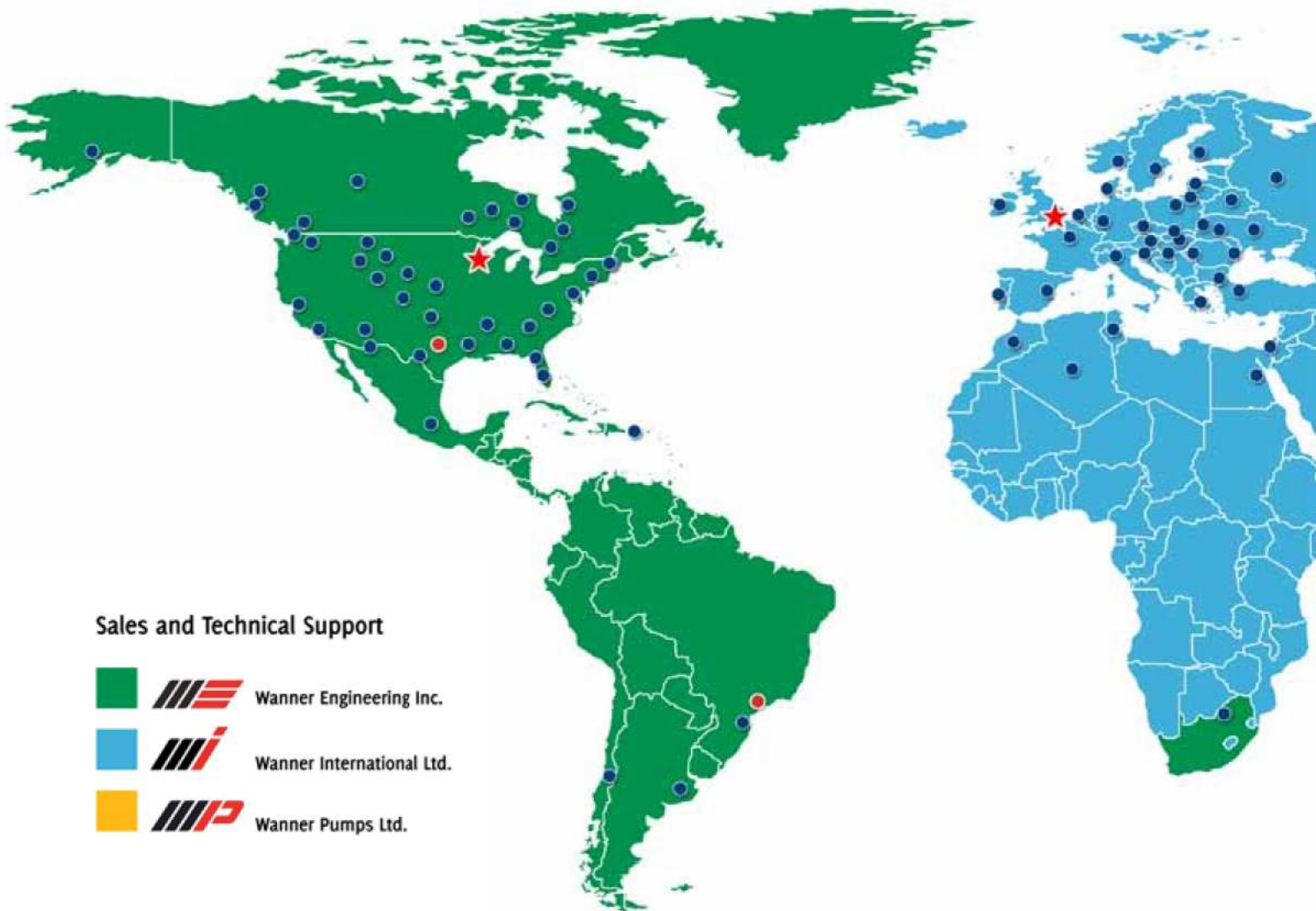

Contact us for the distributor location nearest you.

Algeria  
 Argentina  
 Australia  
 Austria  
 Azerbaijan  
 Belarus  
 Belgium  
 Brazil  
 Bulgaria  
 Canada  
 China  
 Colombia

Croatia  
 Czech Republic  
 Denmark  
 Ecuador  
 Egypt  
 Estonia  
 Finland  
 France  
 Germany  
 Greece  
 Hong Kong  
 Hungary

India  
 Indonesia  
 Ireland  
 Israel  
 Italy  
 Japan  
 Kazakhstan  
 Kuwait  
 Latvia  
 Lithuania  
 Malaysia  
 Mexico

Morocco  
 Netherlands  
 New Zealand  
 Norway  
 Oman  
 Poland  
 Portugal  
 Puerto Rico  
 Qatar  
 Romania  
 Russia  
 Serbia



Hydra-Cell pumps are sold and serviced worldwide by a comprehensive network of factory-trained pump distributors. As specialists in pump technologies, our distributor organizations offer you a vital local resource for technical expertise, product training, sales and service.

Hydra-Cell distributors are located in nearly 70 countries worldwide. In North America specifically, there are more than 100 Hydra-Cell distributor locations to provide local availability for every major commercial, institutional, industrial, and municipal marketplace.

**World Headquarters and Manufacturing**

★ Minneapolis, Minnesota, USA

**Business Units**

- ★ Hampshire, United Kingdom
- ★ Kowloon, Hong Kong
- Wichita Falls, Texas, USA
- Shanghai, China
- São Paulo, Brazil
- Mumbai, India

Saudi Arabia  
 Singapore  
 Slovakia  
 Slovenia  
 South Africa  
 South East Asia  
 South Korea  
 Spain  
 Sweden  
 Switzerland  
 Taiwan  
 Thailand

Tunisia  
 Turkey  
 Ukraine  
 United Arab Emirates  
 United Kingdom  
 United States  
 Uruguay  
 Venezuela  
 Vietnam  
 Yemen



# Hydra-Cell® Application Worksheet



Let us help you determine the best solution for your pumping application. Simply provide the information below, tear out the page, and send it to us.

1. Email to sales@wannerint.com or Fax to +44 (0) 1252 629242
2. Scan the page and email it as an attachment to sales@wannerint.com
3. Mail the page - either in an envelope or fold it, and using the other side as a mailing label, tape the page closed, affix postage and mail it
4. Give it to your local Wanner distributor

## Liquid Information:

Liquid Name: \_\_\_\_\_

Solids: Yes  No  If Yes, size and percentage: \_\_\_\_\_

Liquid Temperature: Operating \_\_\_\_\_ Min \_\_\_\_\_ Max \_\_\_\_\_

Viscosity: Min \_\_\_\_\_ Max \_\_\_\_\_ Specific Gravity: \_\_\_\_\_

Please provide a brief description of the application and liquid characteristics (e.g. abrasive, shear-sensitive)

\_\_\_\_\_  
\_\_\_\_\_

*Please provide MSDS Sheet if available.*

## Equipment Information:

Installation: New  Existing

If existing, previous equipment installed: \_\_\_\_\_

Flow Rate: Operating \_\_\_\_\_ Min \_\_\_\_\_ Max \_\_\_\_\_ Units \_\_\_\_\_

Discharge Pressure: \_\_\_\_\_ Inlet (Suction) Pressure: \_\_\_\_\_

NPSHa: \_\_\_\_\_

Inlet Pipe Diameter: \_\_\_\_\_ Inlet Pipe Length: \_\_\_\_\_

Supply Voltage: \_\_\_\_\_ Phase \_\_\_\_\_ Hertz \_\_\_\_\_

## Contact Information:

Name: \_\_\_\_\_ Date: \_\_\_\_\_

Title: \_\_\_\_\_

Company: \_\_\_\_\_

Address: \_\_\_\_\_

City: \_\_\_\_\_ State/Province: \_\_\_\_\_ Zip/Postal: \_\_\_\_\_

Phone: \_\_\_\_\_ Fax: \_\_\_\_\_

Email: \_\_\_\_\_

Company Website: \_\_\_\_\_

Market/Industry: \_\_\_\_\_





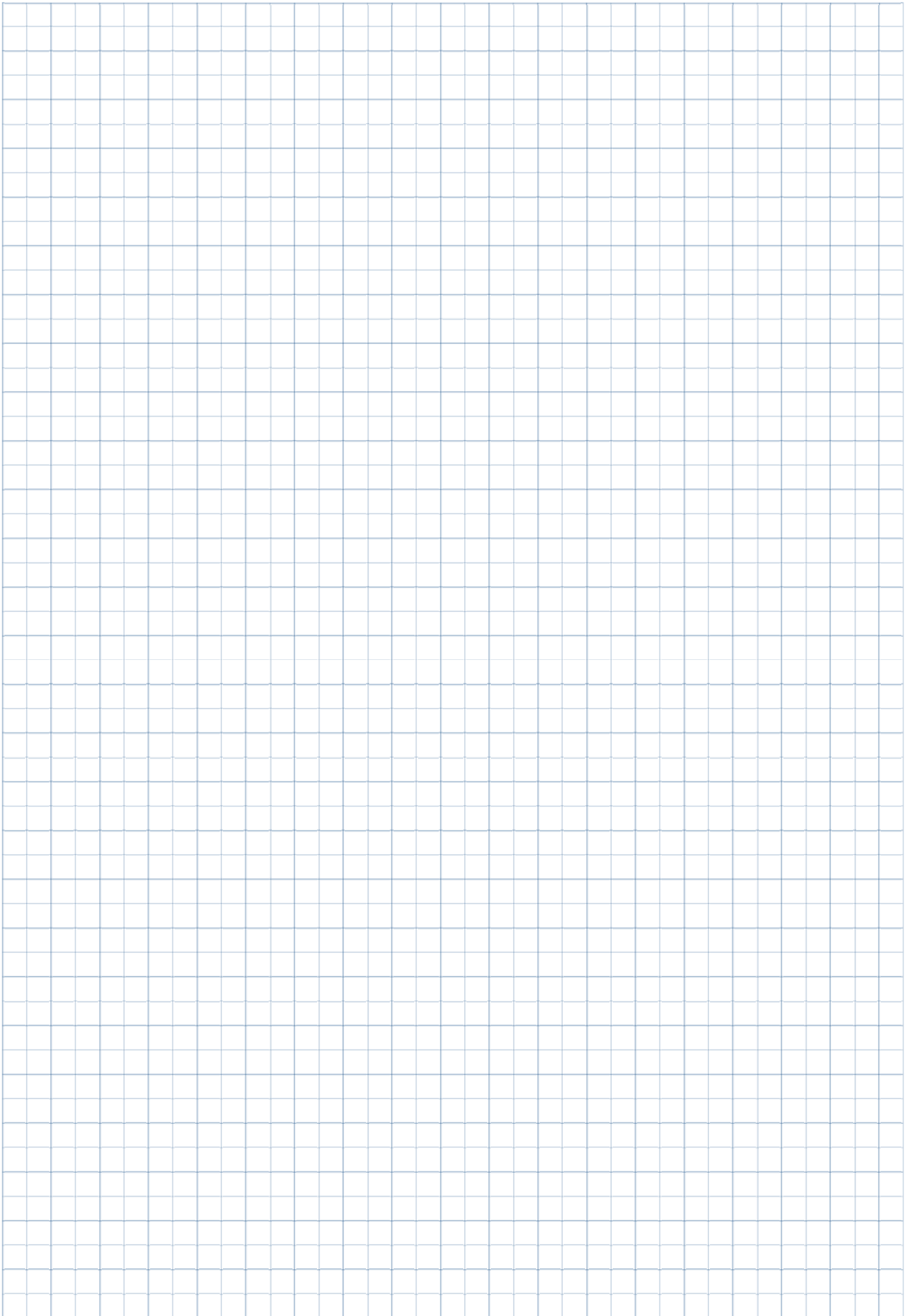

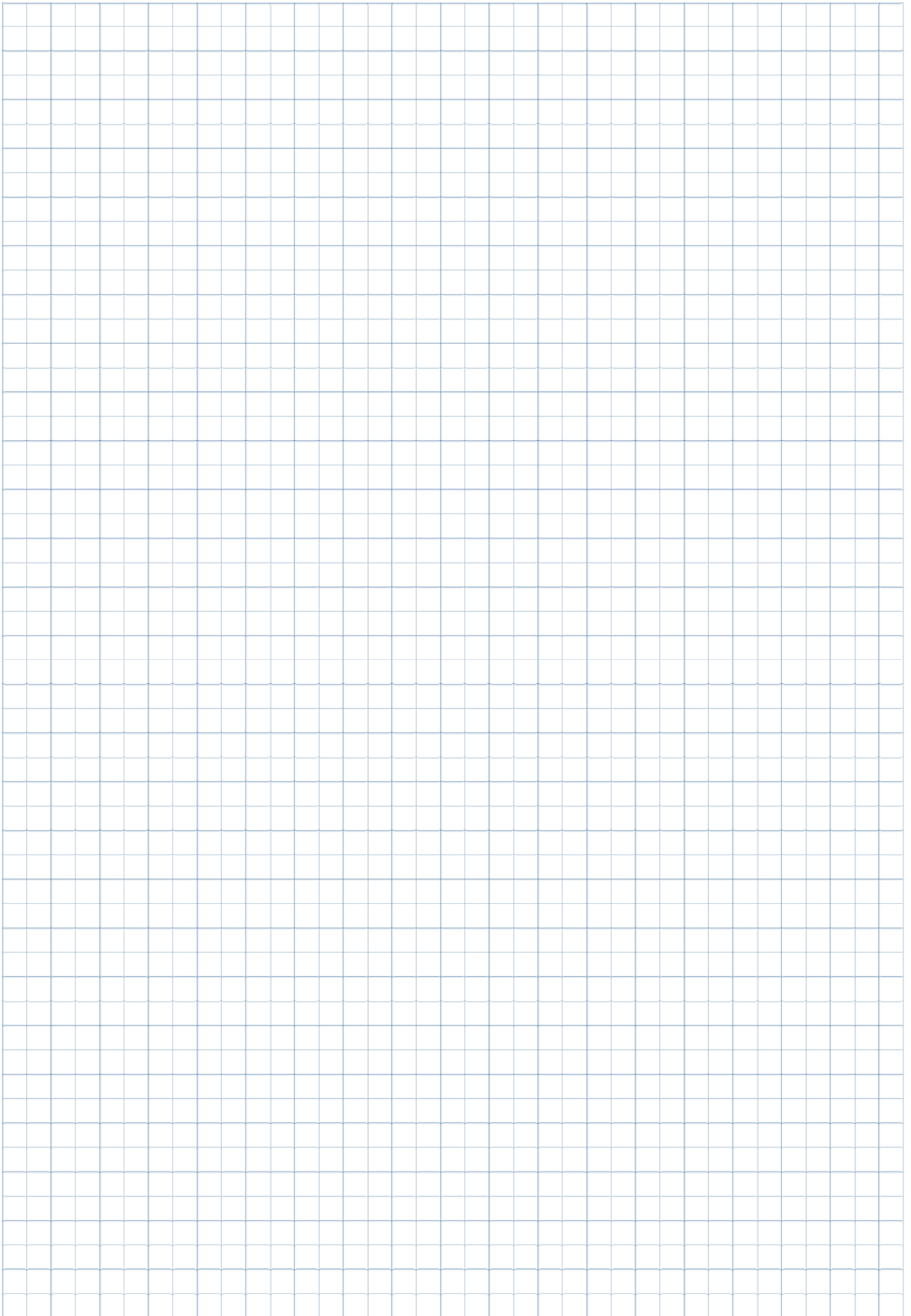



**WANNER**

*Hydra-Cell*<sup>®</sup>

Partners in over 70 Countries



2<sup>e</sup> loswal 23, 1216 BC Hilversum

Tel.: +31 (0)35 628 22 80

info@promotec.nl - www.promotec.nl